

# **DEEP DOWN DETECTIVES**



**Fundamentals:**

**Unit 3, NIV**

**The Good News of God, the Gospel**



Curriculum for preschool and elementary age children,  
training tools, music and other Resources  
are available for download or to order at:  
[www.praisefactory.org](http://www.praisefactory.org)

© 2015 Praise Factory Media all rights reserved. May be reproduced by licensed user for classroom purposes only.

This and many other resources are available online at [www.praisefactory.org](http://www.praisefactory.org)

Scripture quotations marked (NIV) are taken from the Holy Bible, New International Version®, NIV®, Copyright © 1973, 1978, 1984 by Biblica, Inc.™ Used by permission of Zondervan. All rights reserved worldwide.[www.zondervan.com](http://www.zondervan.com)

Scripture quotations marked (ESV) are from The Holy Bible, English Standard Version® (ESV®), copyright © 2001 by Crossway, a publishing ministry of Good News Publishers. Used by permission. All rights reserved.

Scripture quotations marked HCSB are taken from the Holman Christian Standard Bible®, Copyright © 1999, 2000, 2002, 2003, 2009 by Holman Bible Publishers. Used by permission. Holman Christian Standard Bible®, Holman CSB®, and HCSB® are federally registered trademarks of Holman Bible Publishers.

---

# Table of Contents

---

## About Deep Down Detectives Resources

5

## Unit 3 Fundamentals

<b>BIBLE TRUTH 1: God Made Us and We Should Obey Him</b>	<b>7</b>
Unit Overview	9
Song Track Numbers	10
Bible Truth Key Concepts	11
Bible Story with Story Scenes	13
Discussion Questions	35
Coloring Sheets	37
<b>BIBLE TRUTH 2: We Have All Disobeyed God and Deserve His Punishment</b>	<b>45</b>
Unit Overview	46
Song Track Numbers	47
Bible Truth Key Concepts	49
Bible Story with Story Scenes	51
Discussion Questions	75
Coloring Sheets	77
<b>BIBLE TRUTH 3: God Sent Jesus to Pay for the Sins of God's People</b>	<b>85</b>
Unit Overview	86
Song Track Numbers	87
Bible Truth Key Concepts	89
Bible Story with Story Scenes	91
Discussion Questions	115
Coloring Sheets	117
<b>BIBLE TRUTH 4: God Saves All Who Repent of Their Sins and Trust in Jesus as Savior</b>	<b>125</b>
Unit Overview	126
Song Track Numbers	127
Bible Truth Key Concepts	129
Bible Story with Story Scenes	131
Discussion Questions	155
Coloring Sheets	157



## Deep Down Detective Curriculum Resources

These Deep Down Detectives resources are available as free, digital downloads at [praisefactory.org](http://praisefactory.org), or for purchase as hard copies through [amazon.com](http://amazon.com).

## About Deep Down Detectives Fundamentals

### **Deep Down Detectives Fundamentals, ESV/NIV for each unit**

This resource provides the key concepts, the story and small versions of the Story Scene pictures, discussion questions and five activity sheets. It is a compilation of resources taken from the full Deep Down Detectives curriculum for this unit. No lesson plan. Just the core truths. This is a great, basic resource for use at home or informal teaching situations.

## Other Deep Down Detectives Resources

There are four other companion resources for each of the sixteen Deep Down Detectives units:

### **Deep Down Detectives Core Curriculum Book, ESV/NIV for each unit**

The Deep Down Detectives Core Curriculum book contains the curriculum introduction, the lesson plans, stories, music, activities and take home sheets for each Bible Truth in a unit.

### **Deep Down Detectives Small Format Visual Aids, ESV/NIV (Small Format Storyboard Pictures) for each unit**

This resource provides large, colorful signs of the key concepts used in the unit. It also provides colorful storyboard (flannelgraph) pictures to cut out and use as you tell each story. These storyboard pictures are for use with storyboards at least 24" x 36" in size.

### **Deep Down Detectives Visual Aids, ESV/NIV (with Large Format Storyboard Pictures) for each unit**

This resource provides large, colorful signs of the key concepts used in the unit. It also provides colorful storyboard (flannelgraph) pictures to cut out and use as you tell each story. These storyboard pictures are for use with storyboards at least 36" x 48" in size.

### **Deep Down Detectives Visual Aids with Story Scenes, ESV/NIV for each unit**

This resource provides large, colorful signs of the key concepts used in the unit. It also provides easy-to-use colorful scenes that you hold up in sequence as you tell the story. The story text for each scene is printed on the back of each scene as well as on a separate script. There is a set of ten scenes for each story.

All of these materials may be photocopied for non-commercial church, classroom or school use by licensed users.

## Other Resources in the Praise Factory Family of Curriculum

Deep Down Detectives is the second in a family of three, inter-related curriculums:

- Hide 'n' Seek Kids (focus group: ages 2-4; adaptable range: ages 2-pre-K 5's)
- Deep Down Detectives (focus group: ages 4-6's; adaptable range: ages 3-2nd grade)
- PFI: (focus group: grades K-5th grade; adaptable range: pre-K 5's-6th grade)

Each curriculum teaches the same biblical themes, but are presented in greater depth as the children grow and develop. Together, the curriculums work like an expanding spiral of truth that returns to reinforce the same truths with each curriculum, yet leading the children to deeper understanding with each step up.

Learn more about these curriculums as well as other resources and ideas for reaching children with the gospel at: [www.praisefactory.org](http://www.praisefactory.org).



# **DEEP DOWN DETECTIVES**

**Fundamentals:**

**Unit 3, Bible Truth 1**



**What Is the Gospel?**

**It's Salvation through Faith**

**in Jesus Christ...**

**God Made Us and**

**We Should Obey Him!**





---

## Unit 3: The Good News of God, the Gospel

---

### UNIT OVERVIEW

Gospel means “good news.” In the Bible, the gospel is the good news that God sent His Son Jesus to save sinners like you and me from the punishment we deserve for our sins. That salvation is ours when we turn from our sins and trust in Jesus as our own Savior. Now that is good news indeed!

In this unit we will learn four ways the gospel is such good news.

### UNIT BIBLE VERSE: John 3:16

“For God so loved the world that he gave his one and only Son, that whoever believes in him shall not perish but have eternal life.”

### BIG QUESTION UNDER INVESTIGATION: What Is the Gospel?

**ANSWER:** It’s Salvation through Faith in Jesus Christ!

#### OPTIONAL Big Question 3 INTRODUCTION LESSON (Use Hide ‘n’ Seek Kids Unit 3 Material)

Story: The Case of the Stranger’s Very Good News *Acts 8:1-8*

Bible Verse: John 3:16



#### **BIBLE TRUTH 1: God Made Us and We Should Obey Him** (3 Lessons Available)

Story: The Case of the God Who Was Different *Acts 17:16-33*

Bible Verse: Psalm 100:1-4

#### **BIBLE TRUTH 2: We Have All Disobeyed God and Deserve His Punishment** (3 Lessons Available)

Story: The Case of the Squabbling Brothers and Sisters *Romans*

Bible Verse: Ecclesiastes 7:20,29

#### **BIBLE TRUTH 3: God Sent Jesus to Pay for the Sins of God’s People** (3 Lessons Available)

Story: The Case of the Savior, from Start to Finish *Genesis, The Gospels*

Bible Verse: Psalm 119:18,72-73

#### **BIBLE TRUTH 4: God Saves All Who Repent of Their Sins and Trust in Jesus as Their Savior**

(3 Lessons Available)

Story: The Case of Cruddy Crete *Titus*

Bible Verse: Mark 1:15

---

## Deep Down Detectives NIV Songs 3 Track Numbers

---

This is a listing of all songs mentioned in the unit curriculum. You may or may not choose to use all of the songs. They are listed in easy-reference order--NOT in the order used in the curriculum.

You may choose to simply burn a CD/load them onto an mp3 device in this order. Or, you may want to do what we do: choose the songs we want to use and create a play list of them in that order. Then, we burn a CD/upload the play list onto an mp3 device. A teacher only has to click forward to the next song, instead of hunting for the right track. The track number have been included as part of the title of each song, so teachers will still have a reference to the track number listed in the curriculum (same as those listed below), even if you change the order on your customized play list.

### SONGS USED EVERY UNIT OF THE CURRICULUM

- 1 The Classroom Song v.1
- 2 The Classroom Song v.2
- 3 The Classroom Song v.3
- 4 The Classroom Song v.4
- 5 Deep Down Detectives Theme Song
- 6 The Classroom Rules Song
- 7 Let's Pray Song
- 8 The Big Question Box Song
- 9 The Bible Chant Song
- 10 ACTS Prayer Song (Short Version)
- 11 ACTS Prayer Song (Full Version)

#### Why the Extra Songs?

Deep Down Detectives is a curriculum used by a wide age-span of kids. Sometimes one of the other songs is a better fit for your kids. Or, you may simply want to teach them more songs on the same Bible Truth. Use as many or as few as you want.

### UNIT 3: GOD'S GOOD NEWS, THE GOSPEL

- 12 Big Q & A 3 Song
- 13 Big Question 3 Song: What's the Gospel?
- 14 Big Question 3 Bible Verse Song: For God So Loved the World John 3:16
- 15 *Extra Big Question 3 Bible Verse Song: For God So Loved the World John 3:16 (version 2)*
- 16 *Extra Big Question 3 Bible Verse Song: For God So Loved the World John 3:16 (version 3)*
- 17 Big Question 3 Hymn: And Can It Be, v.1 Refrain
- 18 Big Question 3 Praise Song: I Have Decided to Follow Jesus

#### What Is the Gospel?

#### Salvation through Faith in Christ...

#### Bible Truth 1: God Made Us and We Should Obey Him

- 19 Bible Verse: Shout for Joy Psalm 100:1,2

#### Bible Truth 2: We Have All Disobeyed God and Deserve His Punishment

- 20 Bible Verse: There Is Not a Righteous Man Ecclesiastes 7:20,29

#### Bible Truth 3: God Sent Jesus to Pay for the Sins of God's People!

- 21 Bible Verse: He Was Pierced Isaiah 53:5

#### Bible Truth 4: God Saves All Who Repent of Their Sins and Trust in Jesus

- 22 Bible Verse: The Time Has Come Mark 1:15
- 23 *Extra Bible Verse: Help Us, O God, Our Savior Psalm 79:9*

**Unit 3: The Good News of God, the Gospel**

**Unit Big Question (and Answer):** What Is the Gospel? It's Salvation through Faith in Jesus Christ!

**Unit Bible Verse:** "For God so loved the world that he gave his one and only Son, that whoever believes in him shall not perish but have eternal life." John 3:16

**Bible Truth 1 Concept: Salvation through Faith in Jesus Christ...God Made Us and We Should Obey Him**

Who made the world and everything in it? God did! He made it perfectly, back in the very beginning! Everything He made was good. There was no sin in it. It was all just exactly as He planned.

Not only did God make us and the world we live in, He rules over it all. He takes care of us and keeps the world going. He gives us good laws to live by--and consequences if we disobey Him. God is our good King. He knows what is best for us and wants us to live that way. We should worship, love and obey Him.

**Bible Truth 1 Bible Verse: Psalm 100:1-6**

"Shout for joy to the LORD, all the earth. Worship the LORD with gladness; come before him with joyful songs. Know that the LORD is God. It is he who made us, and we are his; we are his people, the sheep of his pasture. Enter his gates with thanksgiving and his courts with praise; give thanks to him and praise his name."

**Learn a Little:** "Know that the LORD is God. It is he who made us."

**Meaning**

God is the good King and Creator of us all. God's people love to praise Him and tell Him how much they love Him and how wonderful He is. They are so happy to be His people who He cares for and loves. They thank Him for being so good to them.

Because God's people are so happy about being His people, it's not enough for them to quietly worship Him. They want to make a joyful noise and sing loudly to Him. They want everyone--the whole earth--to praise God along with them. They want them to gather together with them at church and sing, sing, sing to the LORD, the great and good king!

**Bible Truth 1 ACTS Prayer**

- A** God, we praise You for being the good Creator and King of the world.
- C** We confess that many times we rebel against You and Your good ways. We choose to live life our own way, instead. We need a Savior!
- T** Thank You for being our good Creator and King. Thank You for making everything in the world for Your good purposes. Thank You for being so merciful to us! Thank You for offering us salvation through Jesus, when we repent of our sins and trust Jesus as our Savior.
- S** God, work in our hearts. Help us to turn away from rebelling against You. Help us to trust in Jesus as our Savior. Help us to joyfully obey You, our good and great King. In Jesus' name we pray. Amen.

**Bible Truth 1 Story**

---

**The Case of the God Who Was Different**

*Acts 17:16-33*

**Songs Used in Bible Truth 1**

---

Big Question 3 Bible Verse Song: For God So Loved the World John 3:16

*Extra Big Question 3 Bible Verse Song: For God So Loved the World John 3:16 (version 2)*

*Extra Big Question 3 Bible Verse Song: For God So Loved the World John 3:16 (version 3)*

Big Question 3 Hymn: And Can It Be, v.1 Refrain

Big Question 3 Praise Song: I Have Decided to Follow Jesus

Bible Truth 1 Bible Verse Song: Shout for Joy Psalm 100:1,2

**The Case of the God Who Was Different***Acts 17:16-33***Story-telling Tips**

Ahead of time:

1. Read the Bible verses and story. Pray!
2. Practice telling story with expression. Look for words that might be new to your children. Plan to explain the meaning of them to the children. The numbers in the story correspond to elements of the picture. Practice pointing to the pictures as you read the story. Shorten the story, if necessary, for your child/group of children.
3. If desired, choose a listening assignment for the children (listed below). Listening with a purpose helps the children keep focused and glean more from the story. The three, different assignments allow you to re-tell the story three times with fresh purpose. Answers to the listening assignments are found at the end of the story.

During your presentation:

1. If you are telling the story to a group of children, maintain as much eye contact as possible as you tell the story. Tell the story with enthusiasm and expression. Take time to show each story scene to the children as you tell it. Use the cue numbers in the story to highlight corresponding parts of the picture as you tell the story.
2. The Clue Catcher question at the bottom of each scene helps the children keep engaged with the story.
3. Include the children in your story with a few questions about what they think will happen or words/concepts that might be new to them.
4. Watch the kids for signs that their attention span has been reached. Shorten, if necessary.
5. At end of the story, repeat the listening assignment question and ask for answers. Close in prayer.

**INTRODUCTION/ LISTENING ASSIGNMENTS (Optional)**

**“Our story is called: The Case of the God Who Was Different. Here is your listening assignment... ”**  
*(optional)*

**Detective Dan’s Lesson #1 Listening Assignment:**

I need to find out:

- 1. Who was the God who was different?**
- 2. What made Him so different?**

**Detective Dan’s Lesson #2 Listening Assignment:****Our Bible Verse is Psalm 100:1-6**

“Shout for joy to the LORD, all the earth. Worship the LORD with gladness; come before him with joyful songs. Know that the LORD is God. It is he who made us, and we are his; we are his people, the sheep of his pasture. Enter his gates with thanksgiving and his courts with praise; give thanks to him and praise his name.”

I need to find out:

- 1. Who urged people to worship the LORD and serve Him as their king?**
- 2. Who did worship Him? Who did not?**

**Detective Dan’s Lesson #3 Listening Assignment:**

I found six clues, but only 4 of them are in the story.

They are: a camera; a temple; a stone altar; a sword; the world; and, laughing people.

*Hold each of them up for the children to see as you identify them.*

I need to figure out:

- 1. Which four belong in the story and which two don’t?**
- 2. What did the people of Athens need to confess to the LORD? Did any do this?**

**Read the assignment questions, THEN SAY,**

“Ok, Deep Down Detectives! Put on your best listening ears and see if you can hear the answers to Detective Dan’s questions. When I finish telling the story, we will see if we can answer all the questions.”

*Read the Bible Truth story, answer questions, present the gospel and lead in prayer.**Answers to questions; the gospel; and, ACTS prayer are included with the story text.*

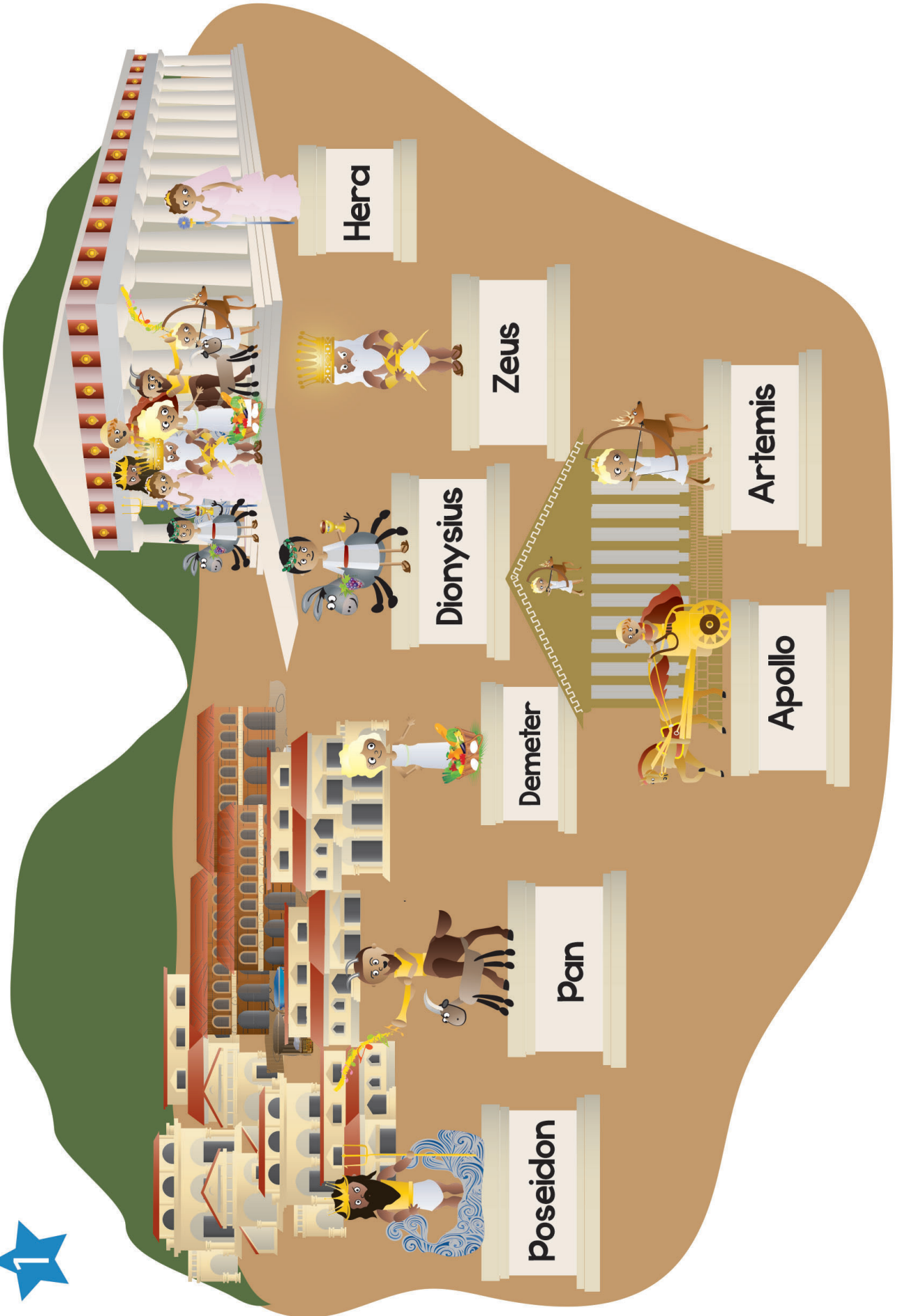

## Story Scene 1

**★ Gods! Gods! Gods! Athens was a city full of fake gods! On buildings. On hills. Everywhere you looked, there was another god.**

**Apollo and Artemis. Demeter and Dionysius; Pan and Poseidon. Hera and, of course, Zeus, the king of all the gods.**

**You might not know these names, but the people of Athens certainly did. And these were just a FEW of the HUNDREDS of gods they worshipped! Wow!**



**Clue Catchers: How many fake gods do you see in this picture?**

1



2

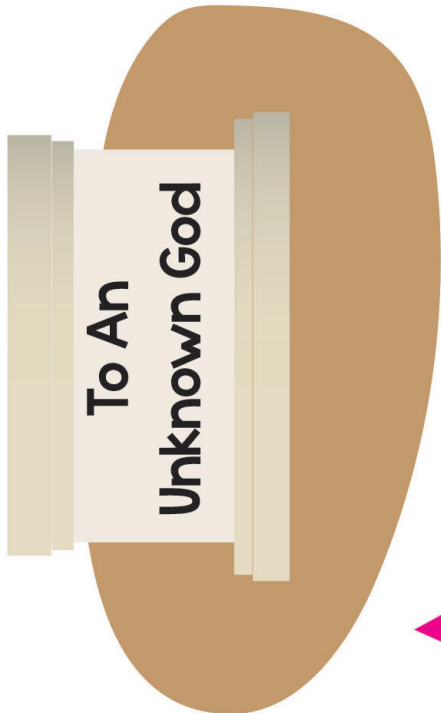

3



## Story Scene 2

The people of Athens took good care of their gods.

- 1 They built them beautiful temples. They laid rich worship gifts at their stony feet.
- 2 They celebrated them with big, worship parties.
- 3 They even laid a stone to honor an Unknown God.

The people of Athens didn't want to leave out any god.



**Clue Catchers: Can you find the stone to honor the Unknown God?**

# THE LORD

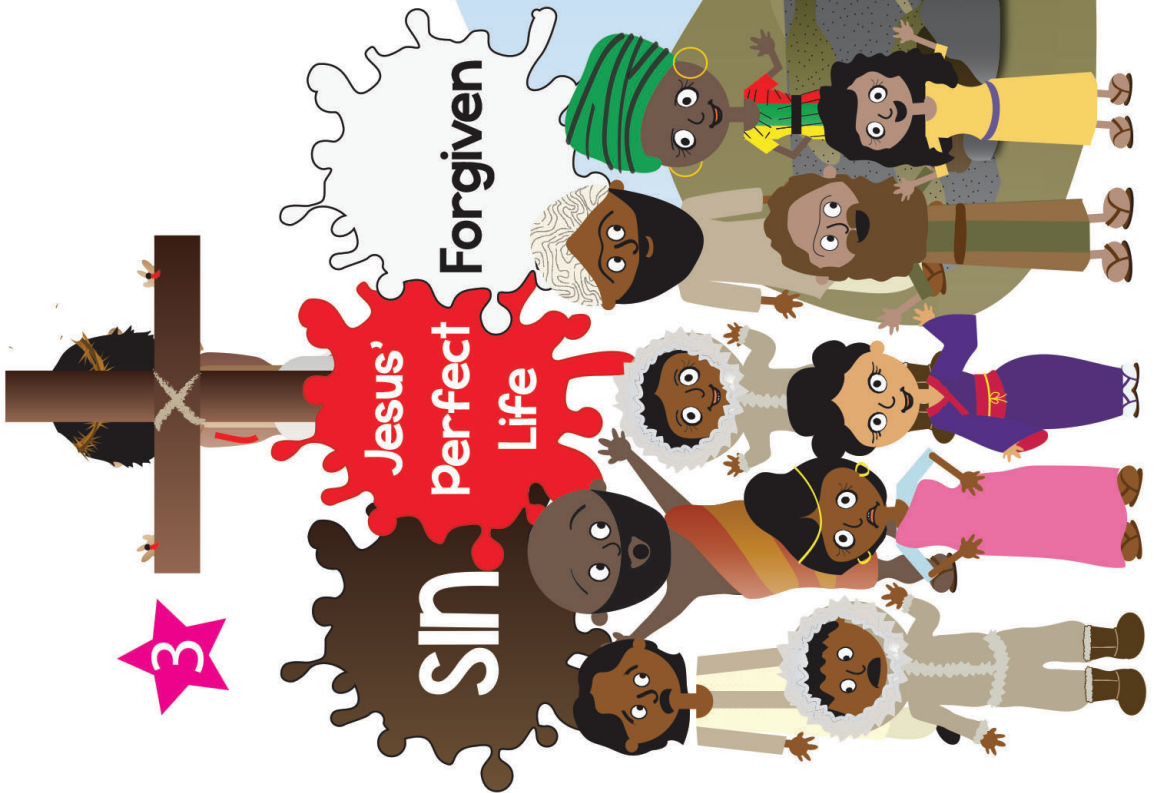

Jesus' Perfect Life

Forgiven

Sin

Holy Spirit



## Story Scene 3

Yes, the people of Athens worshipped hundreds of gods; but, the only god they SHOULD have been worshipping was that  "Unknown God."

He was the REAL, the one, true God! Not many people in Athens knew His name, but I think you do.

*Can you tell me His name?*

It was  the LORD!

He was God the Father who sent  His Son Jesus to be our Savior. He sent  His Holy Spirit to live inside those who trusted in Jesus as their Savior. He made the way for us to become His people forever.

<sup>19</sup> What an amazing God was this one, true God! He was not like of the fake gods of Athens!



Clue Catchers: Can you find Jesus dying on the cross and rising from the dead?

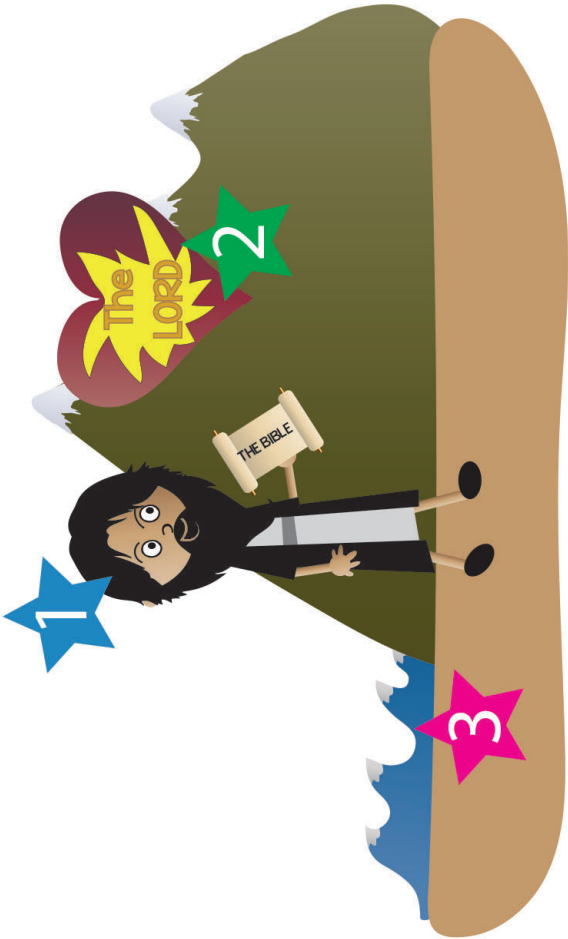

## Story Scene 4

Maybe most of the people in Athens didn't know about the one, true God, but there was (👉) a man named Paul who did. Paul knew the LORD and (👉) loved the LORD and lived for the LORD. He trusted in Jesus, His Son, as his Savior. He had the Holy Spirit living in his heart.

And if there was ONE thing that Paul wanted to do with his life, it was to tell others how they could know and love and live for the LORD...and trust in Jesus as their Savior, too.

👉 So... across the sea, over mountains, and down through valleys went Paul, telling everyone he could about the LORD and how they could know Him through Jesus.

One day, 👉 all this traveling led Paul to a city he had never been to before.

*Can you guess the name of this new city?*

**It was Athens!**

Now Paul had been to many cities that were SMALLER than Athens. And Paul had been to cities that were BIGGER than Athens. But there was something that Paul saw in Athens that he had NEVER seen before in any of those other cities--big or small. 👉 It was this many fake gods!

*How do you think Paul felt when he saw all those fake gods?*

👉 Paul was so upset! Oh, how these people needed to hear about the LORD, the one, true God! How they needed to stop worshipping these fake gods and start worshipping the LORD, instead! How they needed to know His Son, the Savior Jesus! And Paul decided to do something about that, right then and there!



**Clue Catchers: Can you find Paul travelling to other lands with the gospel?**

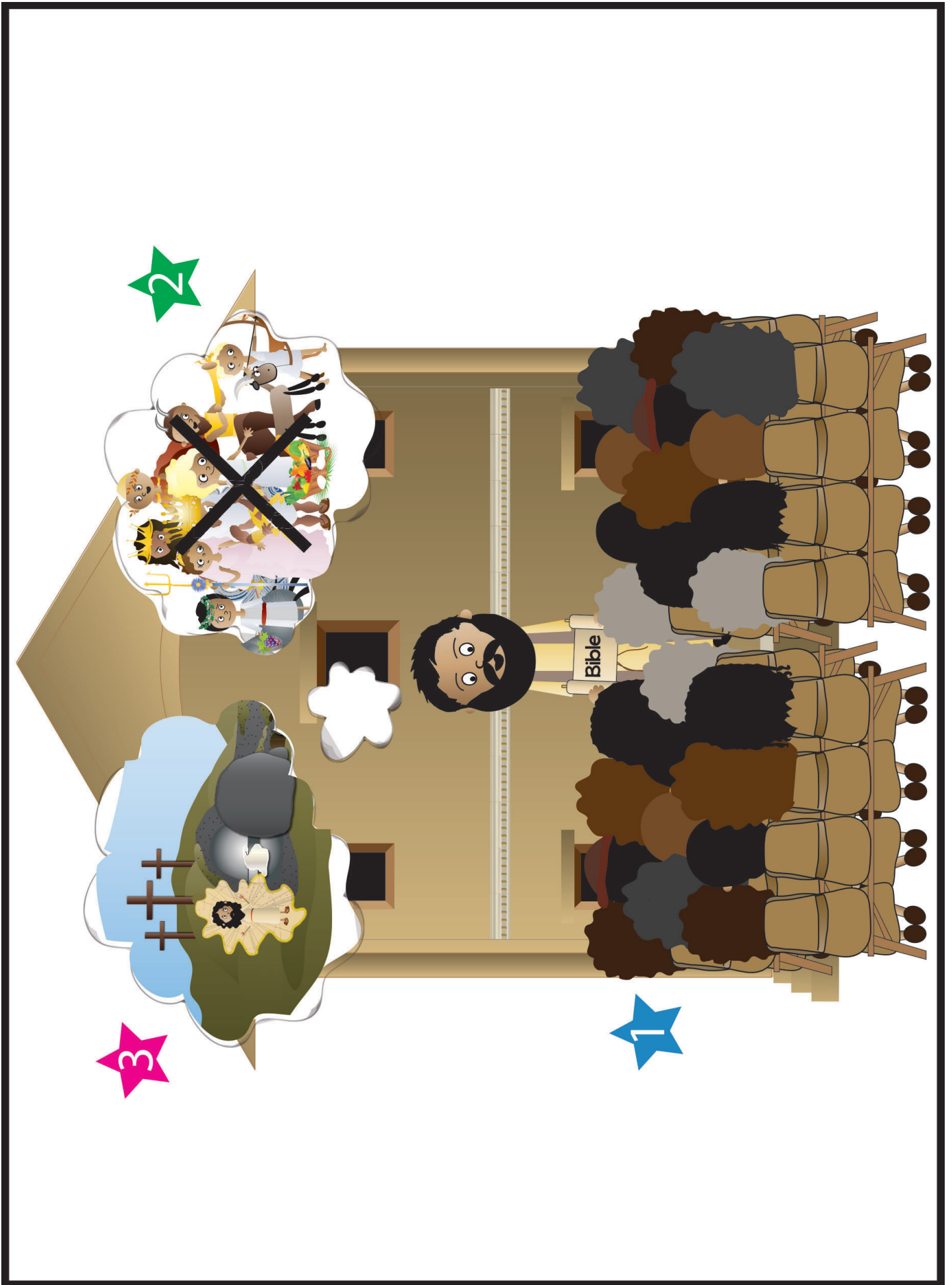

## Story Scene 5

Into  the synagogue-worship place went Paul.

 The gods of Athens are just fakes. The LORD has sent  His Son Jesus to save you, just as He promised. Believe in Him!" he told the people gathered there.



**Clue Catchers: Can you find Paul preaching from the Bible?**





## Story Scene 6

Then down by the temples and  into the marketplace, went  Paul. “Let me tell you about the LORD! Let me tell you about  Jesus, His Son, sent to save you! Worship Him,  not these fake gods!” Paul urged  everyone who would listen.

Word about Paul and his strange, new teaching soon spread through the city and  to the city leaders.

They found Paul and said, “Come up to our important meeting place on Mars Hill and tell us about this new god. We want to hear about him, ourselves.”



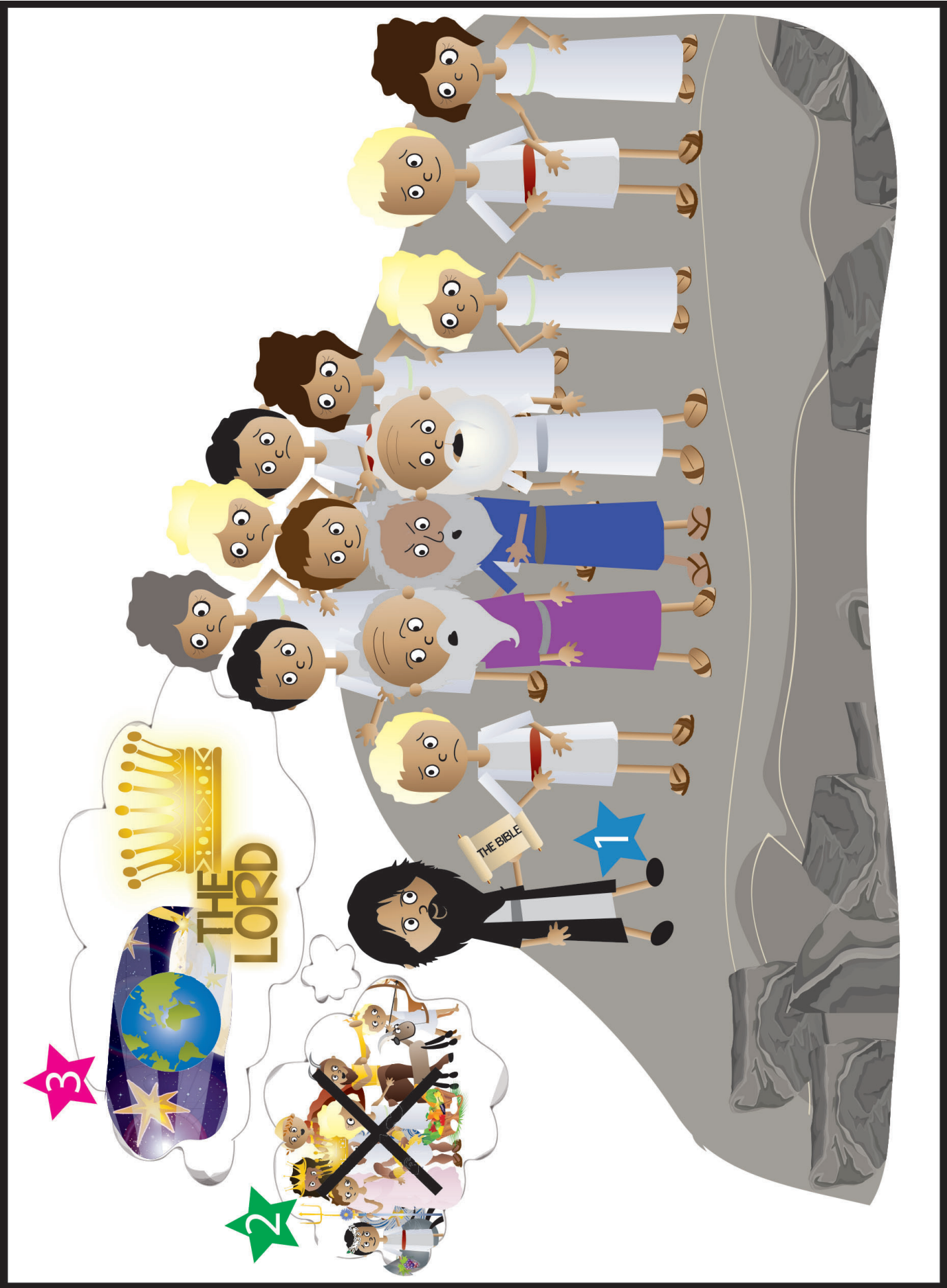



## Story Scene 7

So up, up, up  the big, stony hill called Mars Hill went Paul with the city leaders and many others. How excited Paul was to tell them about the real, one, true God and His Son Jesus! He hoped they would put their trust in Him!

On top of Mars Hill, Paul spoke to the crowd. “People of Athens, what a lot of gods you worship! he exclaimed.

“ But you are worshipping the wrong one! I’ve come to tell you about the one, true God--the one you call ‘the Unknown God.’ His name is  the LORD. He’s the one you should worship. He’s the one who made heaven and earth and everything in it,” Paul told them.

“Your city is filled with the big temples you built to worship your gods, but the LORD is too great to live inside even your biggest temple!” Paul exclaimed.



1



2



Zeus



3

THE LORD



4



## Story Scene 8

“You bring  worship gifts to take care of your gods. You  honor them with worship parties.  You keep them looking bright and shiny. You make sure they don’t fall over.

But the LORD doesn’t need people to take care of Him,” Paul explained. “ He’s the living God...He takes care of Himself...and all of us, too! He made us and gave us life.”





## Story Scene 9

“**1** The LORD is our king and we should obey Him and His good laws; but, the sad news is that we don’t.  
**2** We have all disobeyed Him and deserve His punishment for our sins,” Paul told them.

“But the LORD is so merciful that He made the way for us to be forgiven.” Paul explained.

*Who did God send so we could be forgiven, do you know His name?*

“**3** God sent His Son Jesus to suffer and die on the cross to pay for sins. On the third day, He raised up Jesus from the dead in victory.

Now **4** all who turn away from their sins and trust in Jesus as their Savior can be saved. They can be God’s people and have eternal life with Him,” Paul told them.



**Clue Catchers: Can you find God’s people who Jesus died to save?**

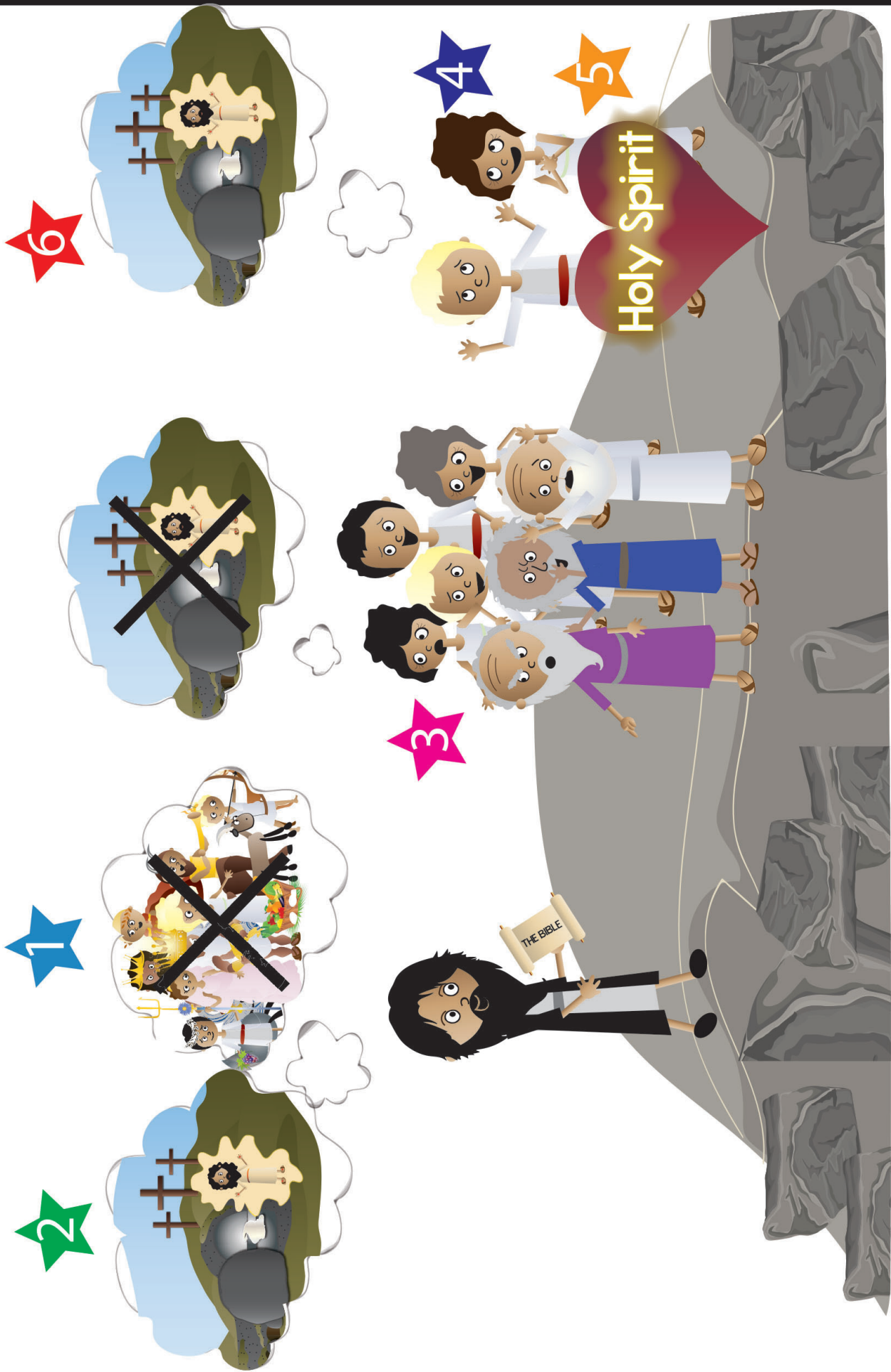



## Story Scene 10

“So  turn away from worshipping your fake gods. Turn to LORD.  Trust in His Son Jesus and be saved! You can be God’s people, too,” Paul urged them.

*What do you think the people of Athens will do? Will they believe in the LORD or not?*

The people of Athens hardly knew what to think. They had never heard of a god like this!

A god who was supposed to be greater than Zeus, the king of their gods; yet, who came to die for sinners... then rose from the dead! Incredible!

 Many people laughed. “Ha, ha! Your god sounds silly! Who would ever believe in him?” they said.

But others,  like Dionysius and Damaris, went to Paul to hear more. As Paul talked,  God’s Holy Spirit worked in their hearts. He helped them turn away from their sins and  trust in Jesus as their Savior.

How happy Paul was! Maybe there still were many fake gods in Athens, but now there was a little group of believers living there, who could keep on telling others the good news of Jesus.



**Clue Catchers: Can you find Damaris and Dionysius who believed in Jesus?**

**Cracking the Case:** (story wrap-up for Listening Assignments)

It's time to see how we did with our Listening Assignment.

**Detective Dan's Lesson 1 Listening Assignment:**

**1. Who was the god who was different?** The LORD was the god who was so different.

**2. What made Him so different?** He was the one, true, living God. He was no fake god, like those the people of Athens worshipped.

**For You and Me:**

The people of Athens worshipped many gods, but only the LORD was the one, true God who created them and they should obey. Paul told the people of Athens how they could know the LORD as their God, by turning away from worshipping their fake gods and trusting in Jesus as their Savior.

**Detective Dan's Lesson 2 Listening Assignment:**

**Our Bible Verse is: Psalm 100:1-6**

"Shout for joy to the LORD, all the earth. Worship the LORD with gladness; come before him with joyful songs. Know that the LORD is God. It is he who made us, and we are his; we are his people, the sheep of his pasture. Enter his gates with thanksgiving and his courts with praise; give thanks to him and praise his name."

**1. Who urged the people to worship the LORD and serve Him as their king?** Paul did.

**2. Who did worship the LORD? Who did not?** Dionysius and Damaris and a few others worshipped the LORD. The rest laughed and kept worshipping their fake gods.

**For You and Me:**

Like the people of Athens, we have so much to worship the LORD for being and doing. He is the one, true God! He has made us and wants us to know Him and love Him. He has offered us to be saved from our sins through Jesus, just like the people of Athens heard.

**Detective Dan's Lesson 3 Listening Assignment:**

Our six clues were: a camera; a temple; a stone altar; a sword; the world; and, laughing people.

**1. Which four belong in our story?**

The temple; stone; world; and laughing people.

**2. What did the people of Athens need to confess to the LORD? Did any do this?**

The people of Athens needed to confess that they had worshipped fake gods, not the LORD, the one, true God. They needed to trust in Jesus as their Savior. Dionysius, Damaris and others did this.

**For You and Me:**

Like Damaris and Dionysius, we should also confess our sins to God. Perhaps we have not worshipped fake gods like they did, but we have all disobeyed God and lived our own way. We all deserve His punishment. But, if we confess our sins and trust in Jesus as our Savior, God will forgive us and make us His people, just like He did for Dionysius and Damaris, long ago.

**The Gospel** (story wrap-up if NOT using Listening Assignments)

**Our Bible Truth is:**

**What is the Gospel?**

**It's Salvation through Faith in Jesus Christ...**

**God made us and we should obey Him!**

God made all people--including you and me! And He made us to know Him, love Him and obey Him. He's our good king. But just like the people of Athens, we need God's forgiveness for disobeying Him. God freely offers it to us when we turn away from our sins and trust in Jesus as our Savior. He loves to help us do this. Ask Him!

*Close in prayer.*

**Closing ACTS Prayer**

- A** God, we praise You for being the good Creator and King of the world.
- C** We confess that many times we rebel against You and Your good ways. We choose to live life our own way, instead. We need a Savior!
- T** Thank You for being our good Creator and King. Thank You for making everything in the world for Your good purposes. Thank You for being so merciful to us! Thank You for offering us salvation through Jesus, when we repent of our sins and trust Jesus as our Savior.
- S** God, work in our hearts. Help us to turn away from rebelling against You. Help us to trust in Jesus as our Savior. Help us to joyfully obey You, our good and great King. In Jesus' name we pray. Amen.

Questions to aid discussion of the key concepts and for use in games

Be familiar with these questions and answers. Look for opportunities to ask questions and discuss their answers, such as while the children work on their coloring pages, as part of their response games, or during play time. Remember: your goal isn't to ask all these questions or only talk to the children about these things. It is to be deliberate in having good conversations with them, however much or little you have.

<p><b>BIG QUESTION</b></p> <p><b>Meaning</b></p> <p><b>Discussion Questions</b></p>	<p>What is the Gospel? It's Salvation through Faith in Jesus Christ!</p> <p>Gospel means "good news." In the Bible, the gospel is the good news that God sent His Son Jesus to save sinners like you and me from the punishment we deserve for our sins. That salvation is ours when we turn from our sins and trust in Jesus as our own Savior.</p> <p><i>choose a few</i></p> <ol style="list-style-type: none"> <li>1. What is the gospel? <i>It's salvation through faith in Jesus!</i></li> <li>2. What does the word "gospel" mean? <i>It means "good news."</i></li> <li>3. Why is the gospel such good news? <i>It tells us how can forgive our sins and make us His people forever!</i></li> <li>4. Who do we need to have faith in? <i>Jesus.</i></li> <li>5. What did Jesus do so we can be saved? <i>He took the punishment for sin when He died on the cross.</i></li> <li>6. What does God want us to turn away from? <i>Our sins.</i></li> <li>7. What does it mean to turn away from our sins? <i>To say "no" to disobeying God and to want to obey Him, instead.</i></li> <li>8. Who can we ask to help us turn away from our sins and trust in Jesus? <i>God! He loves to help us when we ask Him.</i></li> </ol>
<p><b>BIBLE TRUTH</b></p> <p><b>Meaning</b></p> <p><b>Discussion Questions</b></p>	<p>It's Salvation through Faith in Jesus Christ...God made us and we should obey Him!</p> <p>Who made the world and everything in it? God did! He made it perfectly, back in the very beginning! Everything He made was good. There was no sin in it. It was all just exactly as He planned. Not only did God make us and the world we live in, He rules over it all. He takes care of us and keeps the world going. He gives us good laws to live by--and consequences if we disobey Him. God is our good King. He knows what is best for us and wants us to live that way. We should worship, love and obey Him</p> <p><i>choose a few</i></p> <ol style="list-style-type: none"> <li>1. Who made the world? Who made us? <i>God did!</i></li> <li>2. What was the world like with God made it? <i>It was good. There was no sin in it; it was exactly as He had planned.</i></li> <li>3. Who rules over the world as king? <i>God does.</i></li> <li>4. Who keeps the world going and takes care of us? <i>God does.</i></li> <li>5. What did God give us to live by? <i>His good laws.</i></li> <li>6. Who knows the best way for us to live? <i>God does.</i></li> <li>7. Who should we worship, love and obey? <i>God.</i></li> </ol>
<p><b>THE GOSPEL</b></p>	<p>What is God's good news for you and me? <i>The gospel! God made all people--including you and me! And He made us to know Him, love Him and obey Him. He's our good king. But sadly, we have all disobeyed Him and we deserve His punishment. How sad! But God is so merciful that He sent a Savior. His Son, Jesus! Jesus suffered and died on the cross. He offered up His perfect life to God to completely pay for the sins of God's people. That includes us, when we turn away from our sins and trust in Jesus as our Savior. He loves to helps us do this. Ask Him! How good is God to us!</i></p>

*Questions to aid discussion of the key concepts and for use in games*

<p><b>BIBLE TRUTH BIBLE VERSE</b></p>	<p>“Shout for joy to the LORD, all the earth. Worship the LORD with gladness; come before him with joyful songs. Know that the LORD is God. It is he who made us, and we are his; we are his people, the sheep of his pasture. Enter his gates with thanksgiving and his courts with praise; give thanks to him and praise his name.” Psalm 100:1-6</p>
<p><b>Meaning</b></p>	<p>God is the good King and Creator of us all. God’s people love to praise Him and tell Him how much they love Him and how wonderful He is. They are so happy to be His people who He cares for and loves. They thank Him for being so good to them.</p>
<p><b>Discussion Questions</b></p>	<p>Because God’s people are so happy about being His people, it’s not enough for them to quietly worship Him. They want to make a joyful noise and sing loudly to Him. They want everyone--the whole earth--to praise God along with them. They want them to gather together with them at church and sing, sing, sing to the LORD, the great and good king!</p> <p><i>choose a few</i></p> <ol style="list-style-type: none"> <li>1. To whom should all the earth shout for joy? <i>To the LORD.</i></li> <li>2. Who made us and is our good king? <i>The LORD.</i></li> <li>3. Who loves to praise God? <i>God’s people.</i></li> <li>4. Why do God’s people love to praise Him? <i>For being their good God, who loves them, cares for them and has saved them.</i></li> <li>5. Where do God’s people gather together to worship the LORD? <i>At church.</i></li> <li>6. What is the most amazing thing God has done for His people that they love to praise Him for? <i>For sending His Son, Jesus, to be their Savior and pay for their sins so they can be God’s people.</i></li> </ol>
<p><b>BIBLE STORY</b></p>	<p><b>The Case of the God Who Was Different</b></p>
<p><b>Discussion Questions</b></p>	<p><i>choose a few</i></p> <ol style="list-style-type: none"> <li>1. What did Athens have a lot of? <i>Fake gods.</i></li> <li>2. What did the people of Athens build for their fake gods? <i>Big temples.</i></li> <li>3. What did the people of Athens put up for the Unknown God--a god whose name they did not know? <i>They lay a stone down to honor this god.</i></li> <li>4. Who was the Unknown God Paul came to tell them about? <i>The LORD, the one, true God.</i></li> <li>5. What did Paul think about all the fake gods in Athens? <i>He was upset!</i></li> <li>6. Why was Paul so upset about all the fake gods? <i>Because Paul knew they could never save the people of Athens. Only the LORD, the one, true God could.</i></li> <li>7. What did Paul tell the people of Athens about the LORD? <i>That He was the one, true God who made everything in heaven and earth. He was the one they should obey.</i></li> <li>8. What did Paul tell the people of Athens about Jesus? <i>That He was God’s Son sent to save them, if they would turn away from worshipping their fake gods and trust in Him as their Savior.</i></li> <li>9. What did most people do when they heard Paul tell about the LORD? <i>They laughed.</i></li> <li>10. What did Damaris and Dionysius do when they heard Paul tell about the LORD? <i>They turned away from worshipping fake gods and trusted in Jesus as their Savior.</i></li> </ol>

**CAN YOU GUESS BIBLE TRUTH!:**

**What's the Gospel?**

**It's Salvation through Faith  
in Jesus Christ...**

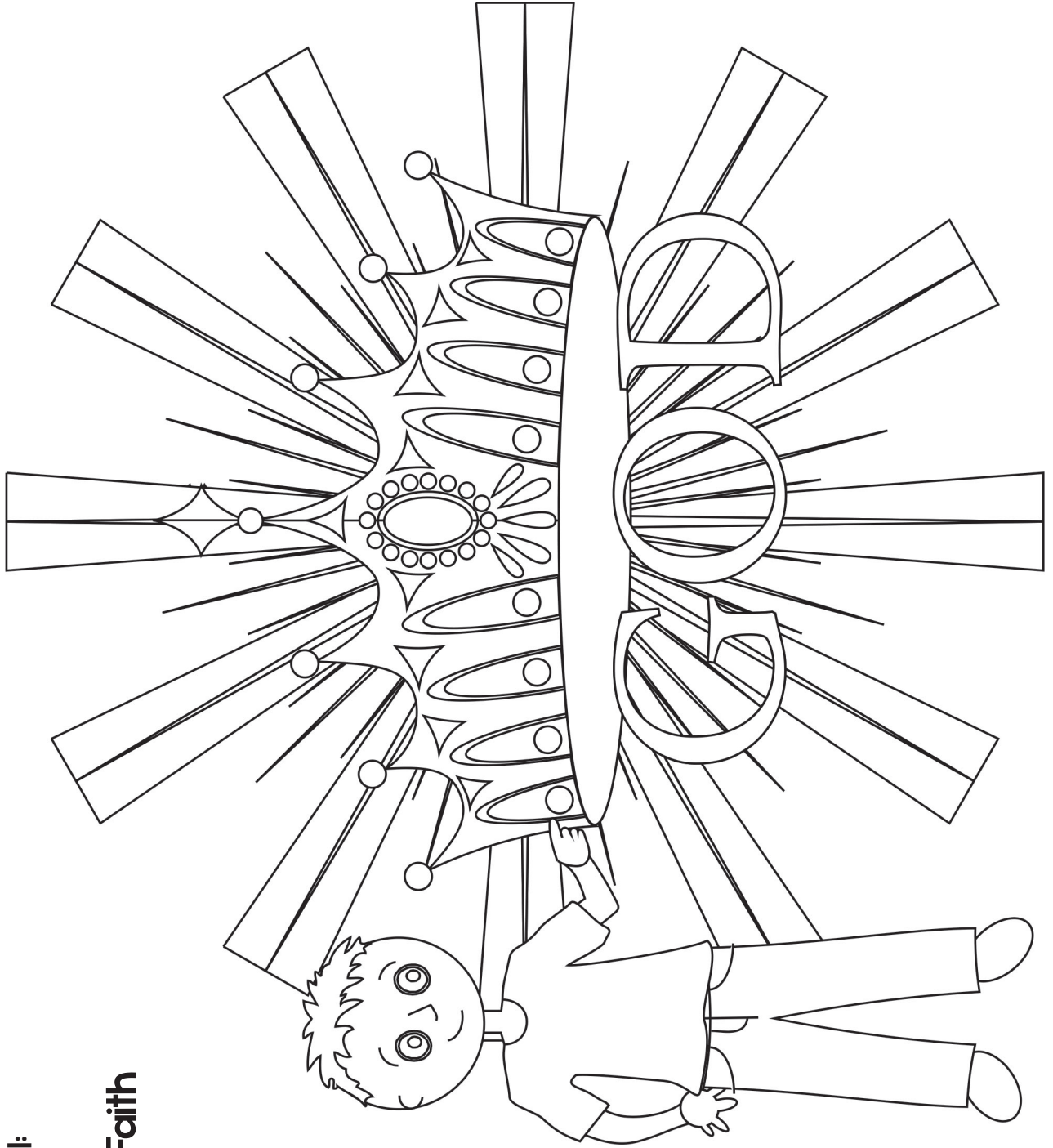

**God made us  
and we should**

-----

**Him!**

**HINT: To do what someone  
tells you to do. Rhymes with  
the word "today."**

# Deep Down Detective Devotion: Unit 3, Bible Truth 1, Lesson 1



**Big Question 3:** What Is the Gospel?

**Answer:** It's Salvation through Faith in Jesus Christ...God made us and we should obey Him!

## Bible Truth 1 Meaning

Who made the world and everything in it? God did! He made it perfectly, back in the very beginning! Everything He made was good. There was no sin in it. It was all just exactly as He planned. Not only did God make us and the world we live in, He rules over it all. He takes care of us and keeps the world going. He gives us good laws to live by--and consequences if we disobey Him. God is our good King. He knows what is best for us and wants us to live that way. We should worship, love and obey Him.

## How do I know this is true? The Bible tells me so!

"Shout for joy to the LORD, all the earth. Worship the LORD with gladness; come before him with joyful songs. Know that the LORD is God. It is he who made us, and we are his; we are his people, the sheep of his pasture. Enter his gates with thanksgiving and his courts with praise; give thanks to him and praise his name." --- Psalm 100:1-6

## Some Questions for You

1. Who made the world? Who made us? *God did!*
2. What was the world like with God made it? *It was good. There was no sin in it; it was exactly as He had planned.*
3. Who rules over the world as king? *God does.*
4. Who keeps the world going and takes care of us? *God does.*
5. What did God give us to live by? *His good laws.*
6. Who knows the best way for us to live? *God does.*
7. Who should we worship, love and obey? *God.*
8. God is our good king, but we all disobey Him. We deserve His punishment for our sins. But God is so merciful! He sent Jesus to save us! What must we do to be saved? *We can ask Him to help us to turn away from our sins and trust in Jesus as our Savior. He delights to do this!*

## Let's Pray!

- A** God, we praise You for being the good Creator and King of the world.
- C** We confess that many times we rebel against You and Your good ways. We choose to live life our own way, instead. We need a Savior!
- T** Thank You for being our good Creator and King. Thank You for making everything in the world for Your good purposes. Thank You for being so merciful to us! Thank You for offering us salvation through Jesus, when we repent of our sins and trust Jesus as our Savior.
- S** God, work in our hearts. Help us to turn away from rebelling against You. Help us to trust in Jesus as our Savior. Help us to joyfully obey You, our good and great King. In Jesus' name we pray. Amen.

## Let's Sing about What We're Learning!

**Big Q & A 3 Song** from *Deep Down Detectives NIV Songs 3, track 12*

(sung to the tune of "Oh, My Darlin' Clementine")

What's the gospel?  
What's the gospel?  
Can you tell me what it is?  
It's salvation through faith in Jesus,  
That's what the gospel is. (repeat)

**Big Question 3 Action Rhyme Song** from *Deep Down Detectives NIV Songs 3, track 13*

### Refrain:

What is the gospel? G-O-S-P-E-L?	"G" is for God, our good King and Creator, O, we should obey Him, but instead we're disobeyers,	Yes, Jesus died upon the cross, the perfect sacrifice, Then on Day Three, He rose again To prove He'd won the fight,
What is the gospel? Can anybody tell me? What is the gospel? Yes, I know what it is! Salvation through faith in Christ, That's what the gospel is.	So S, we need a Savior to save us from our sins, That Savior is Jesus, who "P" took the punishment.	And now "E" everyone who repents and believes in Him, He gives "E-L" eternal life: forever life with Him. Refrain

Go to the *Deep Down Detectives Parent Resources for Unit 3* to get the Bible story and many more resources and songs for this unit at [praisefactory.org](http://praisefactory.org)

**“Shout for joy to the LORD, all the earth. Worship the LORD with gladness;  
come before him with joyful songs. Know that the LORD is God.  
It is he who made us, and we are his; we are his people, the sheep of his pasture.  
Enter his gates with thanksgiving and his courts with praise;  
give thanks to him and praise his name.” -- Psalm 100:1-6**

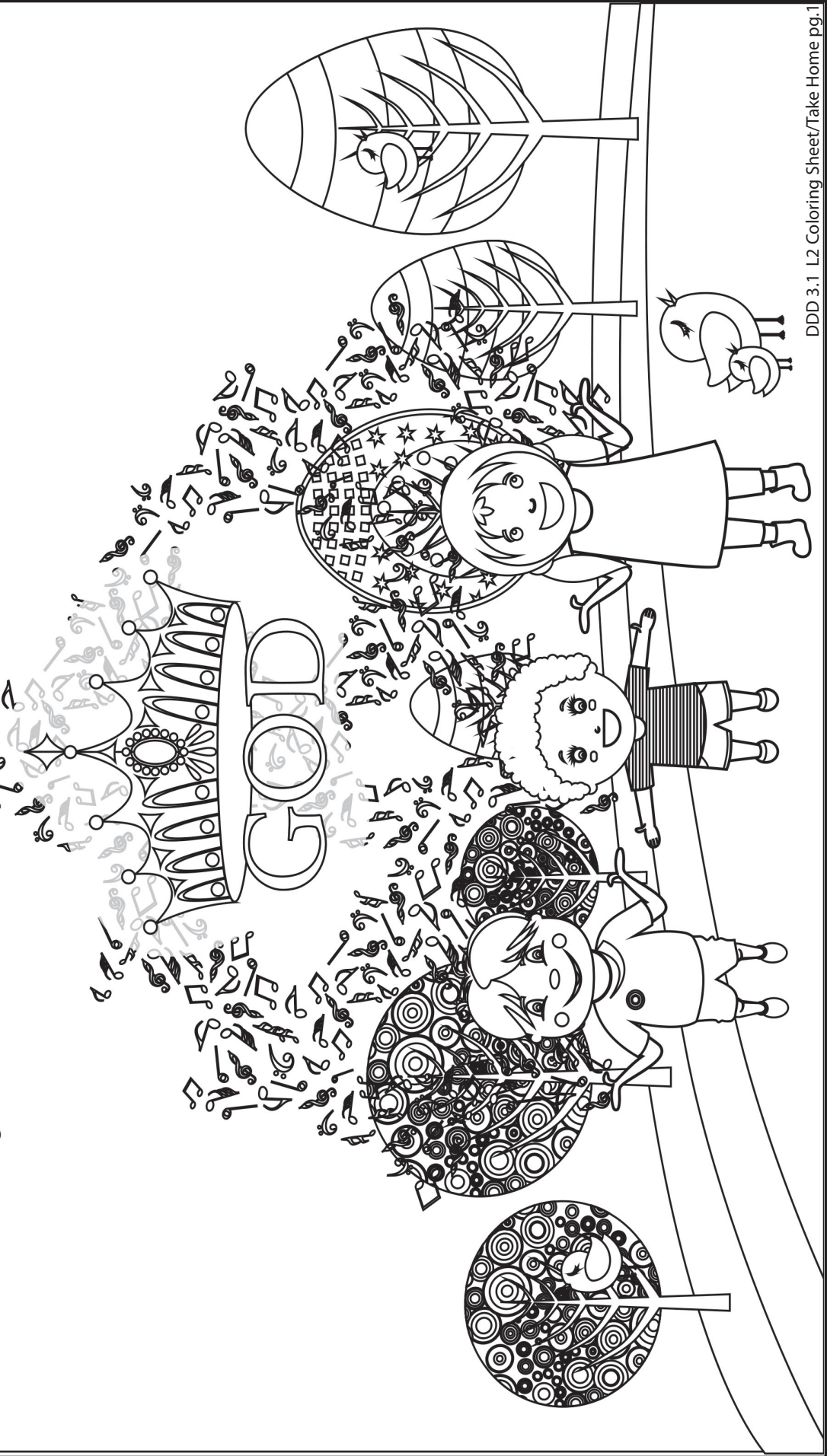

## Deep Down Detective Devotion: Unit 3, Bible Truth 1, Lesson 2



**Big Question 3:** What Is the Gospel?

**Answer:** It's Salvation through Faith in Jesus Christ...God made us and we should obey Him!

### How do I know this is true? The Bible tells me so!

"Shout for joy to the LORD, all the earth. Worship the LORD with gladness; come before him with joyful songs. Know that the LORD is God. It is he who made us, and we are his; we are his people, the sheep of his pasture. Enter his gates with thanksgiving and his courts with praise; give thanks to him and praise his name." --- Psalm 100:1-6

**Learn a Little:** "Know that the LORD is God. It is he who made us."

### Meaning

God is the good King and Creator of us all. God's people love to praise Him and tell Him how much they love Him and how wonderful He is. They are so happy to be His people who He cares for and loves. They thank Him for being so good to them.

Because God's people are so happy about being His people, it's not enough for them to quietly worship Him. They want to make a joyful noise and sing loudly to Him. They want everyone--the whole earth--to praise God along with them. They want them to gather together with them at church and sing, sing, sing to the LORD, the great and good king!

### Some Questions for You

1. To whom should all the earth shout for? *To the LORD.*
2. Who made us and is our good king? *The LORD.*
3. Who loves to praise God? *God's people.*
4. Why do God's people love to praise Him? *For being their good God, who loves them, cares for them and has saved them.*
5. Where do God's people gather together to worship the LORD? *At church.*
6. What is the most amazing thing God has done for His people that they love to praise Him for? *For sending His Son, Jesus, to be their Savior and pay for their sins so they can be God's people.*
7. How can we become God's people? *By turning away from our sins and trusting in Jesus as our Savior. Ask God to help you do this! He loves to answer these prayers!*

### Let's Pray!

- A** God, we praise You for being the good Creator and King of the world.
- C** We confess that many times we rebel against You and Your good ways. We choose to live life our own way, instead. We need a Savior!
- T** Thank You for being our good Creator and King. Thank You for making everything in the world for Your good purposes. Thank You for being so merciful to us! Thank You for offering us salvation through Jesus, when we repent of our sins and trust Jesus as our Savior.
- S** God, work in our hearts. Help us to turn away from rebelling against You. Help us to trust in Jesus as our Savior. Help us to joyfully obey You, our good and great King. In Jesus' name we pray. Amen.

### Let's Sing Our Bible Verse!

**Shout for Joy: Psalm 100:1,2** from *Deep Down Detectives NIV Songs 3, track 19*

Shout for joy to the LORD,  
Shout for joy, all the earth.  
Worship the LORD with gladness,  
Come before Him with joyful song.  
Psalm One hundred, one and two.

Go to the *Deep Down Detectives Parent Resources for Unit 3* to get the Bible story and many more resources and songs for this unit at [praisefactory.org](http://praisefactory.org)



Which four of these clues belong in our story? Which two do not? Put an X in the boxes of the four that belong.

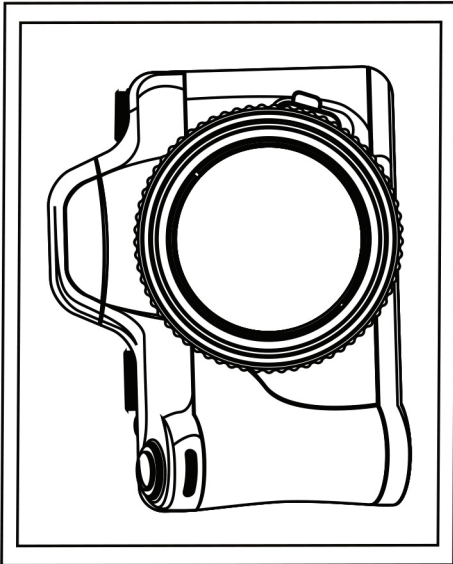

A Camera

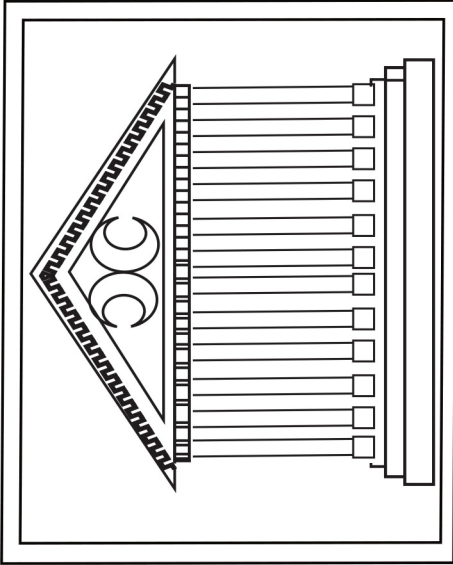

A Temple

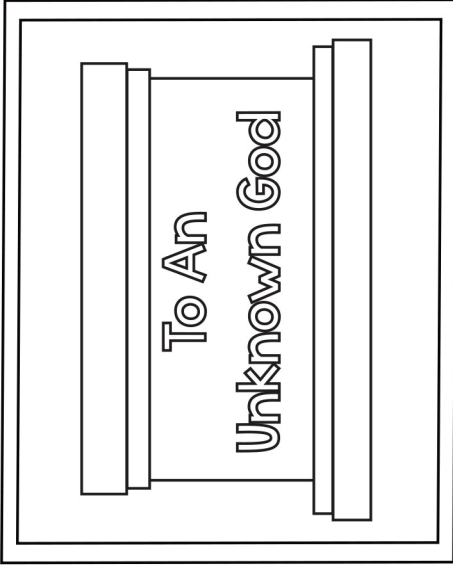

A Stone Altar

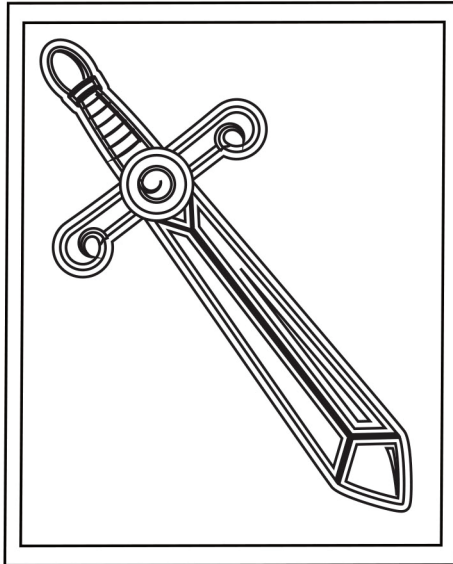

A Sword

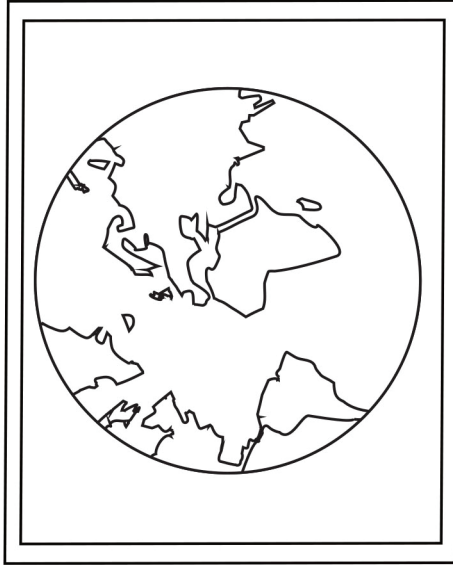

The World

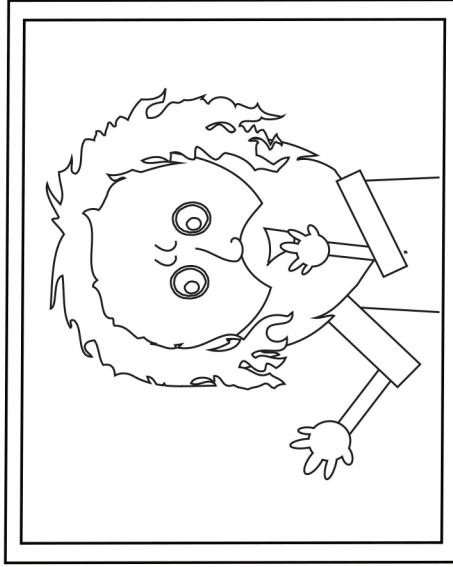

Laughing People

Answer: The temple; the stone; the world and the laughing people belong in the story. The camera and the sword do not.

# Deep Down Detective Devotion: Unit 3, Bible Truth 1, Lesson 3



**Big Question 3:** What Is the Gospel?

**Answer:** It's Salvation through Faith in Jesus Christ...God made us and we should obey Him!

## Bible Truth 1 Meaning

Who made the world and everything in it? God did! He made it perfectly, back in the very beginning! Everything He made was good. There was no sin in it. It was all just exactly as He planned. Not only did God make us and the world we live in, He rules over it all. He takes care of us and keeps the world going. He gives us good laws to live by--and consequences if we disobey Him. God is our good King. He knows what is best for us and wants us to live that way. We should worship, love and obey Him.

## How do I know this is true? The Bible tells me so!

"Shout for joy to the LORD, all the earth. Worship the LORD with gladness; come before him with joyful songs. Know that the LORD is God. It is he who made us, and we are his; we are his people, the sheep of his pasture. Enter his gates with thanksgiving and his courts with praise; give thanks to him and praise his name." --- Psalm 100:1-6

## Some Questions for You

Our six case clues were: a camera; a temple; a stone altar; a sword; the world; and, laughing people.

1. Which four belong in our story?

*The temple; stone altar; the world; and, laughing people.*

2. What did the people of Athens need to confess to the LORD? Did any do this?

*The people of Athens needed to confess that they had worshipped fake gods, not the LORD, the one, true God. They needed to trust in Jesus as their Savior.*

3. Which of the people of Athens did confess their sins and trust in Jesus as their Savior? *Dionysius, Damaris and others did this.*

4. What do we need to confess to God? *That we, too, have chosen to disobey Him.*

5. What does God offer to do with our sins when we turn away from disobeying Him and trust in Jesus as our Savior? *He promises to forgive our sins and make us His people.*

## Let's Pray!

**A** God, we praise You for being the good Creator and King of the world.

**C** We confess that many times we rebel against You and Your good ways. We choose to live life our own way, instead. We need a Savior!

**T** Thank You for being our good Creator and King. Thank You for making everything in the world for Your good purposes. Thank You for being so merciful to us! Thank You for offering us salvation through Jesus, when we repent of our sins and trust Jesus as our Savior.

**S** God, work in our hearts. Help us to turn away from rebelling against You. Help us to trust in Jesus as our Savior. Help us to joyfully obey You, our good and great King. In Jesus' name we pray. Amen.

## Let's Praise God Right Now!

**Big Q & A 3 Hymn: And Can It Be** from *Deep Down Detectives NIV Songs 3, track 17*

### Refrain

Amazing love, how can it be?

That thou, my God, should die for me?

Amazing love, how can it be?

That thou, my God, should die for me?

Words: Charles Wesley Music: Thomas Campbell

**Big Question 3 Praise Song: I Have Decided to Follow Jesus** from *Deep Down Detectives NIV Songs 3, track 18*

I have decided to follow Jesus,

I have decided to follow Jesus,

I have decided to follow Jesus,

No turning back, no turning back.

Go to the *Deep Down Detectives Parent Resources for Unit 3* to get the Bible story and many more resources and songs for this unit at [praisefactory.org](http://praisefactory.org)

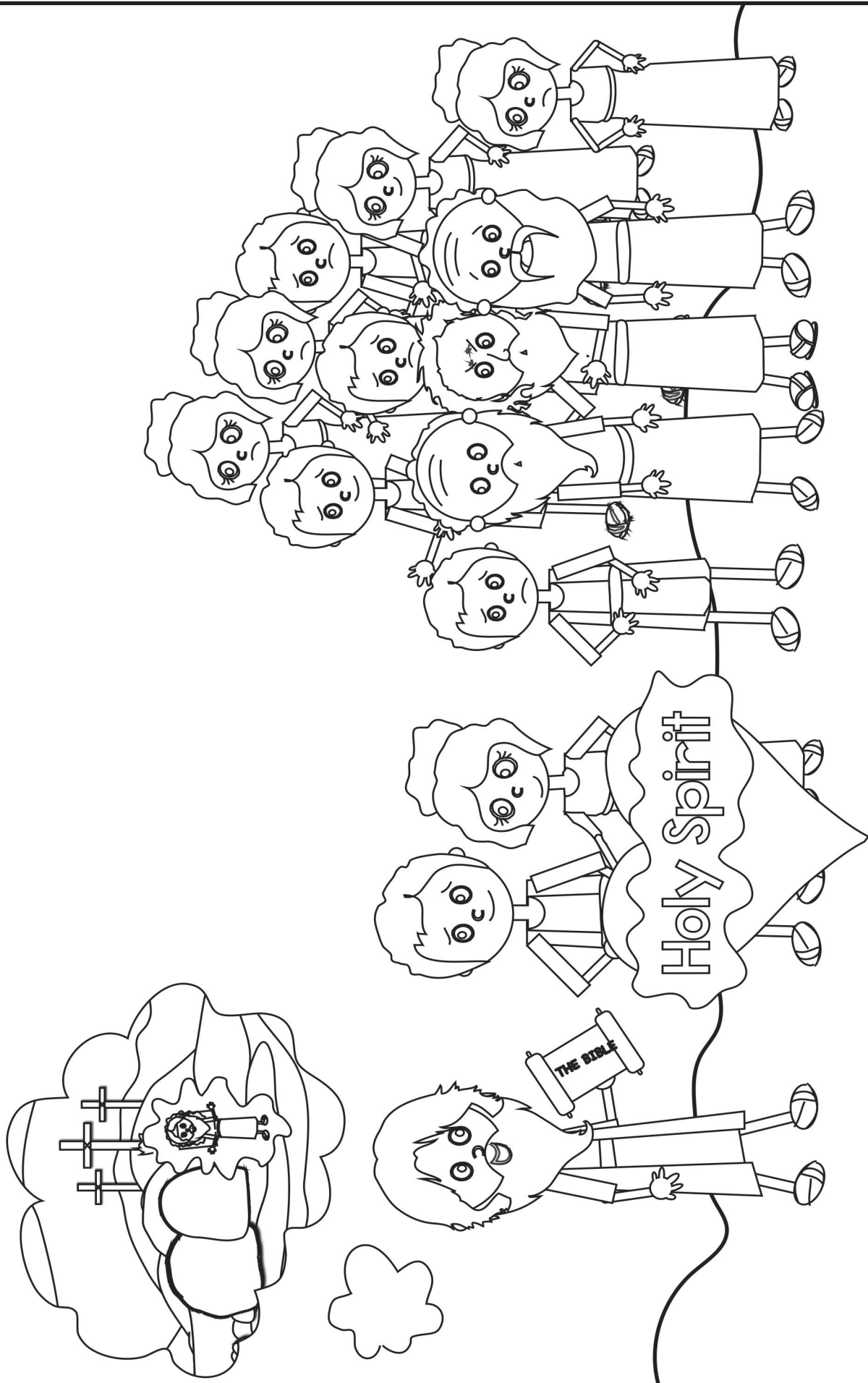

What is the Gospel? It's Salvation through Faith in Jesus Christ...God made us and we should obey Him. Dionysius and Damaris turned from their sins and worshipped the LORD. They trusted in Jesus as their Savior. The rest of the people laughed and kept worshipping their fake gods. Like the people of Athens, we have so much to worship the LORD for being and doing. He is the one, true God! He has made us and we should obey Him. He wants us to know Him and love Him. He has offers us save from our sins through Jesus, just like the people of Athens heard. Ask Him to help you turn away from your sins and trust in Jesus as your Savior! He loves to help us do this!

## The Case of the God Who Was Different Jigsaw Puzzle Page

Acts 17:16-33

Make copies of picture and cut out into an appropriate number of pieces for your children.  
Or, you can print out color versions of this puzzle by downloading it from [praisefactory.org](http://praisefactory.org).

What is the Gospel? It's Salvation through Faith in Jesus Christ! The people of Athens worshipped many gods, but only the LORD was the one, true God who created them and they should obey. Paul told the people of Athens how they could know the LORD as their God, by turning away from worshipping their fake gods and trusting in Jesus as their Savior.

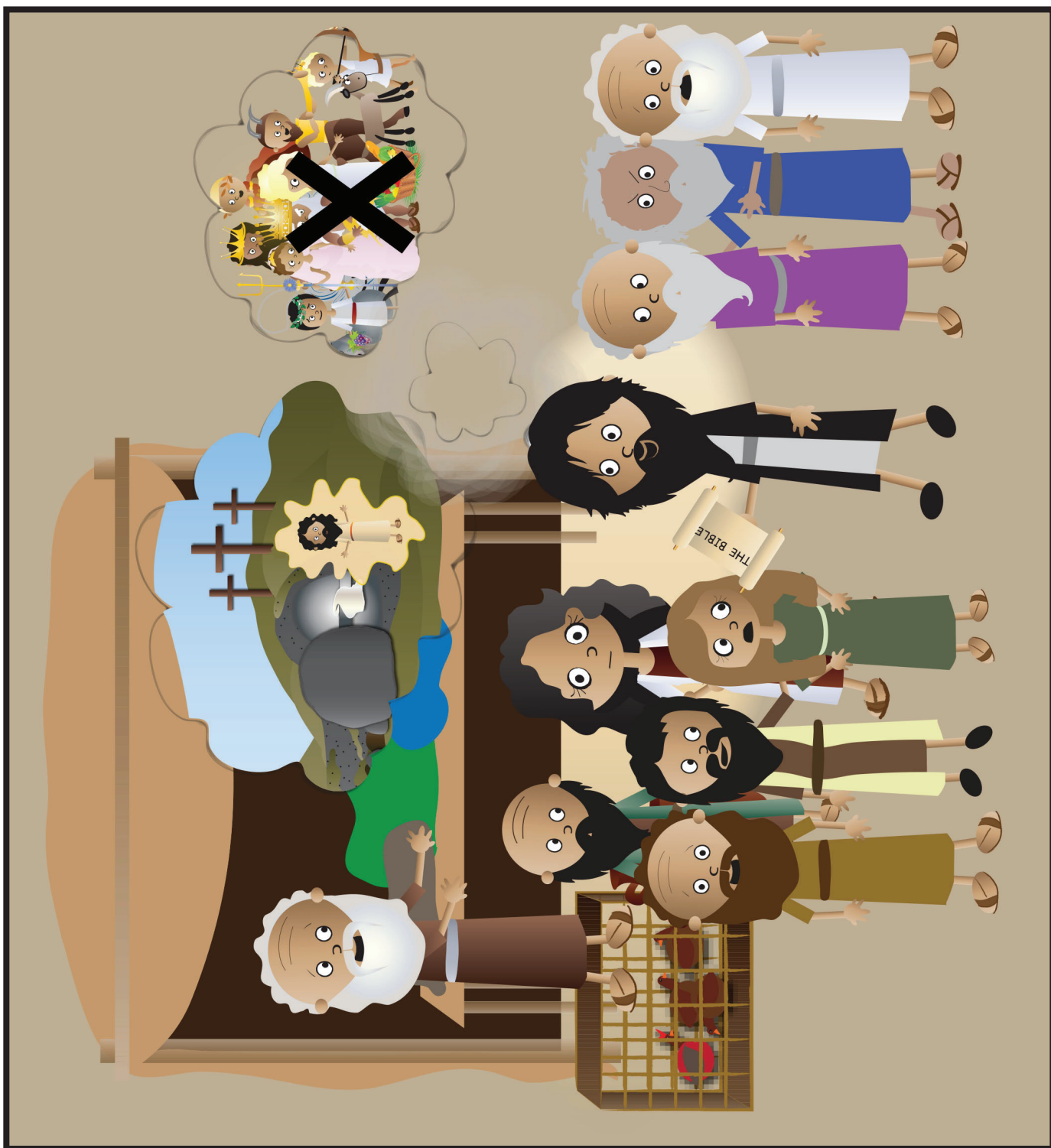

# **DEEP DOWN DETECTIVES**

**Fundamentals:**

**Unit 3, Bible Truth 2**



**What Is the Gospel?**

**It's Salvation through Faith**

**in Jesus Christ...**

**We Have All Disobeyed God  
and Deserve His Punishment!**



---

## Unit 3: The Good News of God, the Gospel

---

### UNIT OVERVIEW

Gospel means “good news.” In the Bible, the gospel is the good news that God sent His Son Jesus to save sinners like you and me from the punishment we deserve for our sins. That salvation is ours when we turn from our sins and trust in Jesus as our own Savior. Now that is good news indeed!

In this unit we will learn four ways the gospel is such good news.

### UNIT BIBLE VERSE: John 3:16

“For God so loved the world that he gave his one and only Son, that whoever believes in him shall not perish but have eternal life.”

### BIG QUESTION UNDER INVESTIGATION: What Is the Gospel?

**ANSWER:** It’s Salvation through Faith in Jesus Christ!

#### OPTIONAL Big Question 3 INTRODUCTION LESSON (Use Hide ‘n’ Seek Kids Unit 3 Material)

Story: The Case of the Stranger’s Very Good News *Acts 8:1-8*

Bible Verse: John 3:16

#### BIBLE TRUTH 1: God Made Us and We Should Obey Him (3 Lessons Available)

Story: The Case of the God Who Was Different *Acts 17:16-33*

Bible Verse: Psalm 100:1-4

#### ➔ BIBLE TRUTH 2: We Have All Disobeyed God and Deserve His Punishment (3 Lessons Available)

Story: The Case of the Squabbling Brothers and Sisters *Romans*

Bible Verse: Ecclesiastes 7:20,29

#### BIBLE TRUTH 3: God Sent Jesus to Pay for the Sins of God’s People (3 Lessons Available)

Story: The Case of the Savior, from Start to Finish *Genesis, The Gospels*

Bible Verse: Psalm 119:18,72-73

#### BIBLE TRUTH 4: God Saves All Who Repent of Their Sins and Trust in Jesus as Their Savior

(3 Lessons Available)

Story: The Case of Cruddy Crete *Titus*

Bible Verse: Mark 1:15

---

## Deep Down Detectives NIV Songs 3 Track Numbers

---

This is a listing of all songs mentioned in the unit curriculum. You may or may not choose to use all of the songs. They are listed in easy-reference order--NOT in the order used in the curriculum.

You may choose to simply burn a CD/load them onto an mp3 device in this order. Or, you may want to do what we do: choose the songs we want to use and create a play list of them in that order. Then, we burn a CD/upload the play list onto an mp3 device. A teacher only has to click forward to the next song, instead of hunting for the right track. The track number have been included as part of the title of each song, so teachers will still have a reference to the track number listed in the curriculum (same as those listed below), even if you change the order on your customized play list.

### SONGS USED EVERY UNIT OF THE CURRICULUM

- 1 The Classroom Song v.1
- 2 The Classroom Song v.2
- 3 The Classroom Song v.3
- 4 The Classroom Song v.4
- 5 Deep Down Detectives Theme Song
- 6 The Classroom Rules Song
- 7 Let's Pray Song
- 8 The Big Question Box Song
- 9 The Bible Chant Song
- 10 ACTS Prayer Song (Short Version)
- 11 ACTS Prayer Song (Full Version)

#### Why the Extra Songs?

Deep Down Detectives is a curriculum used by a wide age-span of kids. Sometimes one of the other songs is a better fit for your kids. Or, you may simply want to teach them more songs on the same Bible Truth. Use as many or as few as you want.

### UNIT 3: GOD'S GOOD NEWS, THE GOSPEL

- 12 Big Q & A 3 Song
- 13 Big Question 3 Song: What's the Gospel?
- 14 Big Question 3 Bible Verse Song: For God So Loved the World John 3:16
- 15 *Extra Big Question 3 Bible Verse Song: For God So Loved the World John 3:16 (version 2)*
- 16 *Extra Big Question 3 Bible Verse Song: For God So Loved the World John 3:16 (version 3)*
- 17 Big Question 3 Hymn: And Can It Be, v.1 Refrain
- 18 Big Question 3 Praise Song: I Have Decided to Follow Jesus

#### What Is the Gospel?

#### Salvation through Faith in Christ...

#### Bible Truth 1: God Made Us and We Should Obey Him

- 19 Bible Verse: Shout for Joy Psalm 100:1,2

#### Bible Truth 2: We Have All Disobeyed God and Deserve His Punishment

- 20 Bible Verse: There Is Not a Righteous Man Ecclesiastes 7:20,29

#### Bible Truth 3: God Sent Jesus to Pay for the Sins of God's People!

- 21 Bible Verse: He Was Pierced Isaiah 53:5

#### Bible Truth 4: God Saves All Who Repent of Their Sins and Trust in Jesus

- 22 Bible Verse: The Time Has Come Mark 1:15
- 23 *Extra Bible Verse: Help Us, O God, Our Savior Psalm 79:9*



**Unit 3: The Good News of God, the Gospel**

**Unit Big Question (and Answer):** What Is the Gospel? It's Salvation through Faith in Jesus Christ!

**Unit Bible Verse:** "For God so loved the world that he gave his one and only Son, that whoever believes in him shall not perish but have eternal life." John 3:16

**Bible Truth 2 Concept: Salvation through Faith in Jesus Christ...We Have All Disobeyed God and Deserve His Punishment**

God is our good Creator. He made us with a spirit so we can know and love Him. He is our good King. He gave us good laws that show us how to love Him and love each other. Life is most wonderful when we know and love God, and we live as He wants us to live.

But instead of choosing God and His wonderful way of life, we have all chosen to disobey Him and His good laws. We have chosen to live life our own, selfish way, instead. This is what the Bible calls sin. Because God is good, He hates sin...and He will punish it. And oh, how terrible is God's punishment for sin! It is to live apart from Him and everything good forever! Every single one of us deserve this punishment for our sins.

But God isn't only good; He's merciful, too. Merciful means treating us better than we deserve, and that's just exactly how God offers to treat us. Yes, our sins must be punished, but God has chosen to take that punishment on Himself. That's why He sent Jesus, His own dear Son, to earth. Jesus came to take the punishment we deserved for our sins when He suffered and died on the cross. God promises to forgive all who turn away from their sins and trust in Jesus as their Savior. That can even include you and me! Isn't God amazing? How great is God's love for us!

**Bible Truth 2 Bible Verse: Ecclesiastes 7:20,29**

"There is not a righteous man on earth who does what is right and never sins... This only have I found: God made mankind upright, but men have gone in search of many schemes."

**Learn a Little:** "There is not a righteous man on earth who does what is right and never sins."

**Meaning**

In the beginning, God created the heavens and the earth. He created it all good. Oh, how wonderful was the love that those first people had for God! Oh, how wonderful it was to know Him and to obey Him! The big Bible word for loving God and living His good way is "righteous."

But that's not the way things are now. Sadly, we all have chosen to disobey God. We want to do things our own way, not God's good way. We make sneaky schemes and plan how we can get what we want or do what we want, instead of what God wants. Our hearts are not full of love for God or for others as they should be.

No one is righteous anymore. No one, that is, except Jesus, God's Son. God sent Jesus live a perfect, righteous life and give it as the payment for our sins. We can have Jesus' righteousness and become one of God's people, when we turn away from our sins and trust in Jesus as our Savior. God loves to help us do this. Ask Him!

**Bible Truth 2 ACTS Prayer**

- A** God, we praise You for being the good God who hates sin.
- C** We confess that we have all rebelled against You and Your good ways. We have all chosen to live life our own way instead. We need a Savior!
- T** Thank You for not just being good, but for being merciful, too. Thank You for taking the punishment we deserve on Yourself that we might be saved. Thank You for offering us salvation through Jesus, when we repent of our sins and trust Jesus as our Savior.
- S** God, work in our hearts. Help us to turn away from living against You and Your good ways. Help us to trust in Jesus as our Savior. Help us to love You and know You. Help us to obey Your good laws. In Jesus' name we pray. Amen.

**Bible Truth 2 Story**

**The Case of the Squabbling Brothers and Sisters**

*Romans*

**Songs Used in Bible Truth 2**

Big Question 3 Bible Verse Song: For God So Loved the World John 3:16

*Extra Big Question 3 Bible Verse Song: For God So Loved the World John 3:16 (version 2)*

*Extra Big Question 3 Bible Verse Song: For God So Loved the World John 3:16 (version 3)*

Big Question 3 Hymn: And Can It Be, v.1 Refrain

Big Question 3 Praise Song: I Have Decided to Follow Jesus

Bible Truth 2 Bible Verse Song: There Is Not a Righteous Man Ecclesiastes 7:20,29

**The Case of the Squabbling Brothers and Sisters***Romans***Story-telling Tips**

Ahead of time:

1. Read the Bible verses and story. Pray!
2. Practice telling story with expression. Look for words that might be new to your children. Plan to explain the meaning of them to the children. The numbers in the story correspond to elements of the picture. Practice pointing to the pictures as you read the story. Shorten the story, if necessary, for your child/group of children.
3. If desired, choose a listening assignment for the children (listed below). Listening with a purpose helps the children keep focused and glean more from the story. The three, different assignments allow you to re-tell the story three times with fresh purpose. Answers to the listening assignments are found at the end of the story.

During your presentation:

1. If you are telling the story to a group of children, maintain as much eye contact as possible as you tell the story. Tell the story with enthusiasm and expression. Take time to show each story scene to the children as you tell it. Use the cue numbers in the story to highlight corresponding parts of the picture as you tell the story.
2. The Clue Catcher question at the bottom of each scene helps the children keep engaged with the story.
3. Include the children in your story with a few questions about what they think will happen or words/concepts that might be new to them.
4. Watch the kids for signs that their attention span has been reached. Shorten, if necessary.
5. At end of the story, repeat the listening assignment question and ask for answers. Close in prayer.

**INTRODUCTION/ LISTENING ASSIGNMENTS (Optional)**

**"Our story is called: The Case of the Squabbling Brothers and Sisters. Here is your listening assignment..."**  
(optional)

**Detective Dan's Lesson #1 Listening Assignment:**

I need to know:

**To squabble means to argue about something.**

1. Who were the brothers and sisters who were squabbling?
2. What were they squabbling about?

**Detective Dan's Lesson #2 Listening Assignment:****Our Bible Verse is Ecclesiastes 7:20,29:**

"There is not a righteous man on earth who does what is right and never sins... This only have I found: God made mankind upright, but men have gone in search of many schemes."

I need to know:

1. What two kinds of families did the believers in Rome come from?
2. What did they need to remember that would help them stop squabbling with each other?

**Detective Dan's Lesson #3 Listening Assignment:**I found six clues, but two of them are **NOT** in the story.

They are: Jews; a jar; Gentiles; fake gods; a bear; and a house.

*Hold each of them up for the children to see as you identify them.*

I need to know:

1. Which four belong in the story and which two don't?
2. Who thanked God for saving them through Jesus?

**Read the assignment questions, THEN SAY,**

"Ok, Deep Down Detectives! Put on your best listening ears and see if you can hear the answers to Detective Dan's questions. When I finish telling the story, we will see if we can answer all the questions."

*Read the Bible Truth story, answer questions, present the gospel and lead in prayer.  
Answers to questions; the gospel; and, ACTS prayer are included with the story text.*

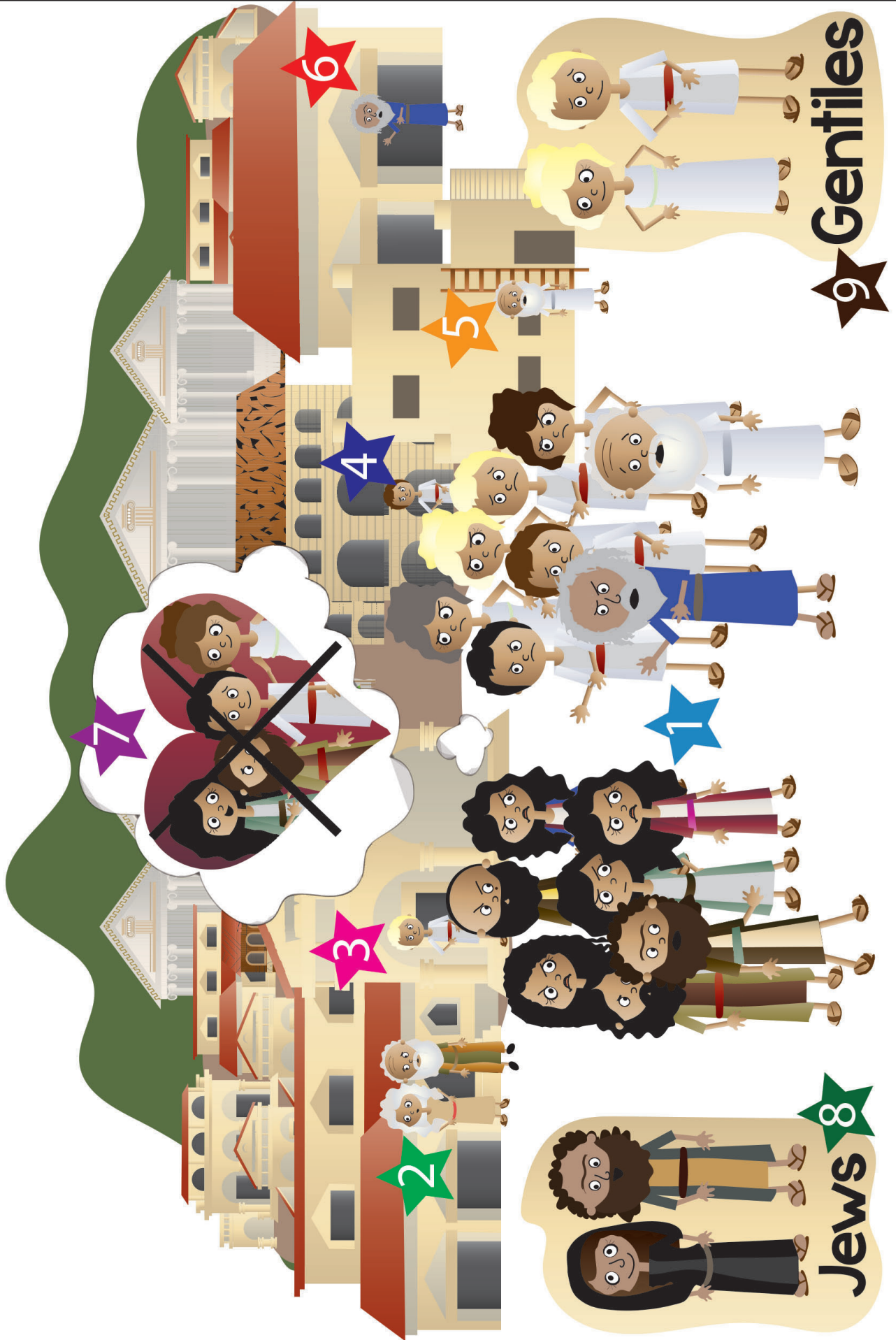

## Story Scene 1

Squibble, squabble, squibble squabble. ★ The believers in the big city of Rome were fighting with each other.

At ★ Priscilla and Aquila's house; and at ★ Aristobulus' house. At ★ Narcissus' house, and ★ two other houses, little groups of believers gathered to worship God.

They were all saved through Jesus. They were all part of God's family. And they should have been loving each other like sisters and brothers; but, they weren't! ★ They were fighting with each other, instead. Squibble, squabble!

How do you think they were fighting each other? Hitting with their fists? Kicking with their legs?

*What do you think?*

No, they weren't hitting each other with their fists. No, they weren't kicking each other with their legs. But, oh, how they were fighting and hurting each other with the squibble-squabbling words that came out of their mouths!

What was all the fuss about? Well, it had to do with what kind of family you came from—a family of ★ Jews or a family of ★ Gentiles.

Jew and Gentile. Have you ever heard of those Bible family names? Let's find out what they are.



**Clue Catchers: Can you find the Jews and Gentiles in the pictures?**



Jews



10 Big, Love Laws

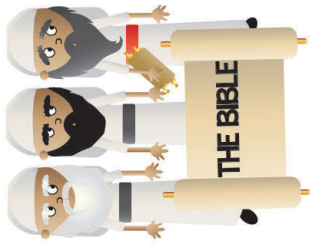

THE LORD



Friendship with God Laws



Live Together Laws

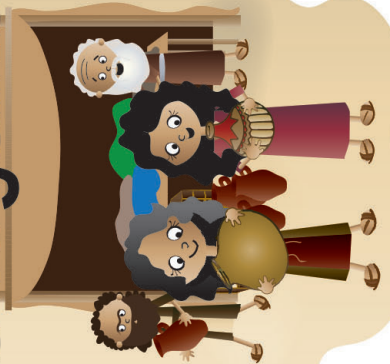

## Story Scene 2

Some of the believers were  Jews. They came from families who  worshipped the LORD. They grew up  learning the Bible and trying to obey its laws... ALL of them... and there were A LOT! (Laws is another word for rules.) Let me tell you about them.

 There were...the Ten, Big Laws God gave them.

*Can you remember the special name of the Ten, Big Laws?*

The special name of these laws is the 10 Commandments. They were the LOVE laws. These laws told how to  love God and  love one another. That was the FIRST kind of laws that God gave the Jews to obey.

But there were more laws than just those! There was a SECOND kind of laws that God gave the Jews.  These were the FRIENDSHIP WITH GOD laws. They told the Jews what worship gifts they needed to give to God when they disobeyed Him. These laws kept them in friendship with God.

But there was even more laws than those! There was a THIRD kind of laws that God gave the Jews.  These were the LIVE TOGETHER laws. These told the Jews how to live their everyday lives--what clothes they should wear; what food they should eat; how to take care of sick people; what to do when they had arguments; and, other everyday things like that.

Wow! What a lot of laws God gave the Jews! But God had a good purpose for every one of them. These laws helped everyone know what God is like. And, they helped everyone see that the Jews were God's special people, living His way, and waiting for Him to send the Savior one day.



**Clue Catchers: Can you find the three different kinds of laws and name them?**

# God's Laws



1



4



Jewish  
Christians

3

Forgiven

Jesus' Perfect Life

Sin

2

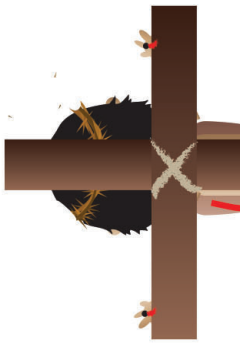



## Story Scene 3

And at just the right time, God DID send the Savior--Jesus!

1 Jesus lived a perfect life. He kept all of God's good laws. Then 2 He suffered and died on the cross, giving His life as the final, perfect worship gift that paid for sins. On the third day, 3 Jesus rose from the dead, showing that He had beaten sin and death for all who would turn away from their sins and trust in Him as their Savior. Jesus had made the way for us to be friends with God!

When these Jews heard the good news of Jesus, they were so happy! Here was the Savior they had been waiting for! He had paid for their sins! 4 They trusted in Him as their Savior. Now they were God's people, saved through Jesus.

There is the special name for people who have Jesus as their Savior. Do you know what it is?

*Can you tell me?*

**They are called Christians.**

**And so now, these Jews weren't just Jews anymore. Now they were Christians.**



**Clue Catchers: Can you find Jesus risen from the dead?**

YES!!!!

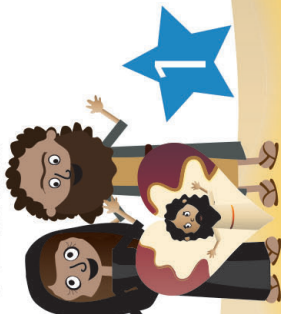

Jewish  
Christians



# 10 Big, Love Laws



THANK YOU, JESUS!



Jewish  
Christians

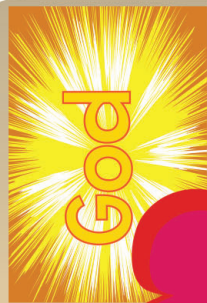

Jesus Gave Us Forever Friendship  
with God

YES!!!!

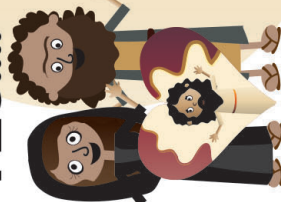

Jewish  
Christians

# Live Together Laws

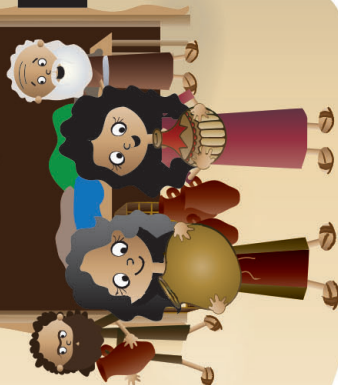

## Story Scene 4

But what should these Jewish Christians do with all those laws from God's Word? They had obeyed them for so long! Should they keep on obeying them now that Jesus had come? They thought about this A LOT!

Let's see... well,  they **KNEW** they should keep on obeying God's Ten, Big, Love laws—the 10 Commandments. They still needed to keep on loving God and others, like the LOVE laws taught. That was clear.

And,  they **KNEW** that Jesus had paid for their sins. His life had been the final worship gift. He gave them FOREVER friendship with God. So they did NOT have to keep the FRIENDSHIP WITH GOD laws anymore.

But what about  all those LIVE TOGETHER laws? The ones about what Jews should eat and drink and do in their everyday lives? The Savior Jesus had come. Now they were Christians. Were they supposed to keep on living together like Jews, too?

*Do you think God wanted them to keep those laws still?*

Many of the Jews **LIKED** those LIVE TOGETHER laws. Actually they **LOVED** them. They didn't want to get rid of them...and they wanted everyone else to keep them, too. They thought that **EVERYONE** should become a Christian, saved through Jesus; but, they should keep on living together like Jews... **EVEN** the people who didn't grow up as Jews!

Uh oh, that might just cause a problem or two...especially for the believers who came from that **OTHER** kind of Bible family-- the Gentiles. Let me tell you about them.



**Clue Catchers: Can you find Jesus on the cross? He gave God's people forever friendship with God.**

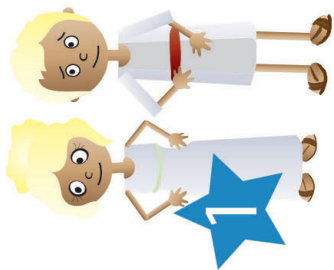

# Gentiles



SIN Jesus' Perfect Life

Forgiven

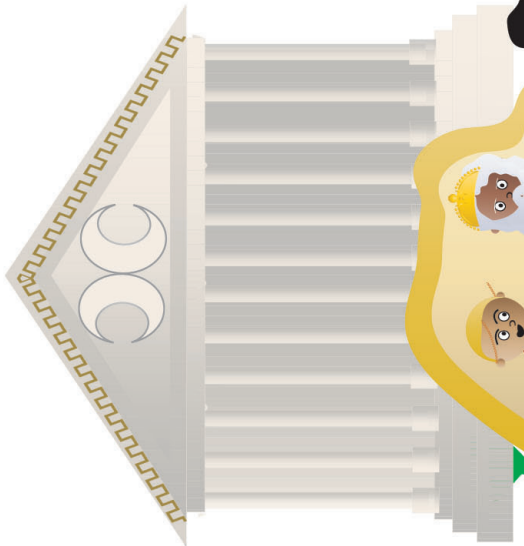

4



Gentile Christians

5



6

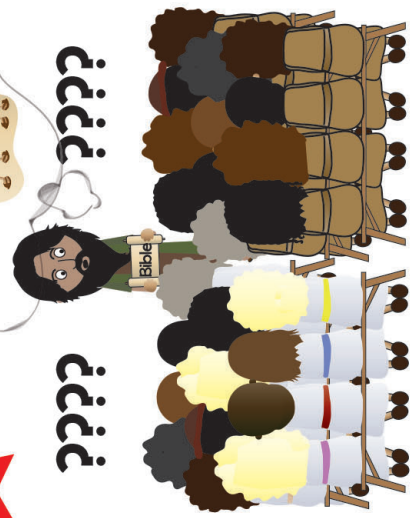

????

????

3



## Story Scene 5

1★ Gentiles came from families who had NOT grown up knowing the Bible or keeping its laws—not the Ten, Big, Love laws or the Friendship with God laws, or even the Live Together laws. 2★ They had grown up worshipping fake gods. And actually, worshipping those fake gods meant doing some very bad things that disobeyed God’s good laws--3★ like those big, worship parties they had.

But when these Gentiles heard 4★ the good news of Jesus, they left their fake gods and their bad ways behind. 5★ They trusted in Jesus as their Savior and they wanted to live God’s way now. They became Christians.

6★ They went to church with the other Jewish and Gentile believers. And as they listened to God’s Word, they heard all about all those laws for the first time. Now everyone had a question...

61 *Can you guess what the question was?*

**The question was: what should they--the people from Gentile families-- do with all of those laws?**



**Clue Catchers: Can you find the Gentiles worshipping fake gods?**

YES!!!!



Gentile  
Christians



10 Big, Love Laws

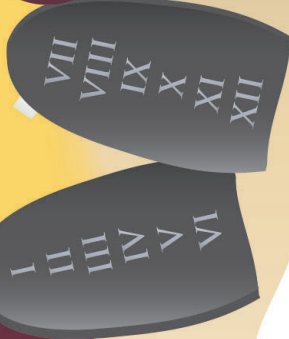
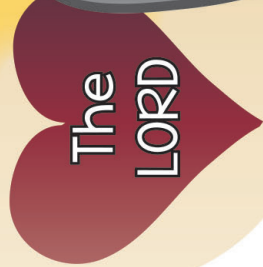

Live Together Laws

no!!!!



Gentile  
Christians

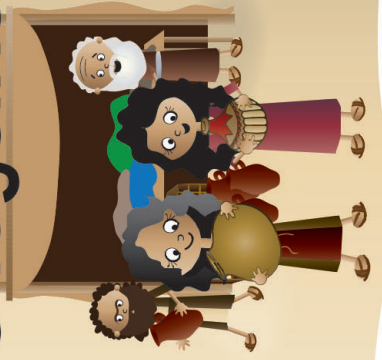

Jewish  
Christians

YES!!!!



THANK YOU, JESUS!



Gentile  
Christians

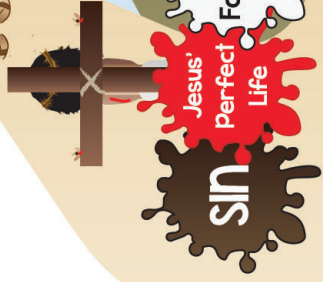



Jesus Gave Us Forever Friendship  
with God

## Story Scene 6

Like the Jewish Christians, the Gentile Christians **KNEW** that they should obey  God's Ten, Big, Love laws—the 10 Commandments. They still needed to keep on loving God and others, like those **LOVE** laws taught. That was clear.

And like the Jewish Christians, they **KNEW** that Jesus had paid for their sins.  His life had been the final worship gift. He gave them **FOREVER** friendship with God. So they did **NOT** have to keep the **FRIENDSHIP** **WITH** **GOD** laws anymore.

But what about those  **LIVE TOGETHER** laws? The laws that told the Jews how to live together? The Savior had come. Surely Gentiles didn't need to obey **THOSE** laws! Surely they didn't need to live like Jews to be Christians! That didn't make sense! They were saved through Jesus, not those laws! Nope.  They would **NOT** obey the **LIVE TOGETHER** laws. No way!

And so came  all of the squibble-squabbling.



**Clue Catchers: Can you find the Live-Together Laws that the Gentiles did NOT think they should keep?**

1



3

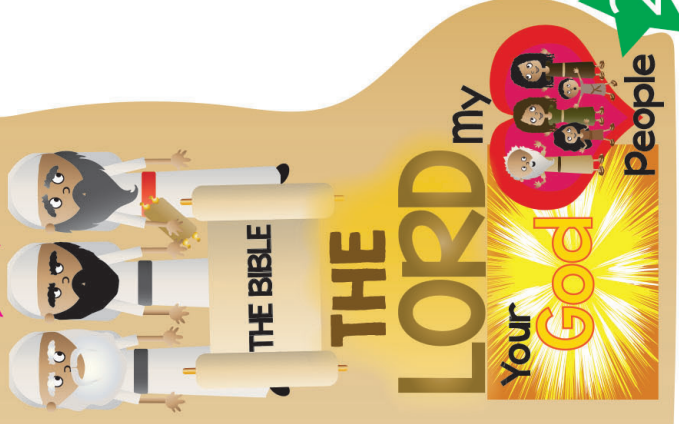

2



4



5



## Story Scene 7

“ We’re better than you, Gentiles,” the Jewish Christians said.

“Long ago,  God chose US to be His special people through Abraham.  He chose US to write down the Bible, His Word. He gave US the great promises about the Savior Jesus coming.”

“Jesus came from OUR family. He was a Jew!”

“God gave US His good laws—the LOVE laws and the FRIENDSHIP WITH GOD laws and the LIVE TOGETHER laws. All of them!”

“We obey them and so should you! That’s what God’s people have always done,” they told the Gentiles.

“Maybe we ARE just Gentiles. Maybe our families didn’t come from God’s special people, long ago. But we believe in the Savior Jesus NOW!  And a lot more of US believe in Him than you, Jews!”

“ Look who God is choosing to make into His special people NOW—it’s us, Gentiles. And we DON’T have to keep all of your Live Together Laws!” they squabbled back.

 **Clue Catchers:** The Jews were proud that God chose to write down the Bible and give it to them first. Can you find the scroll of the Bible in this picture?

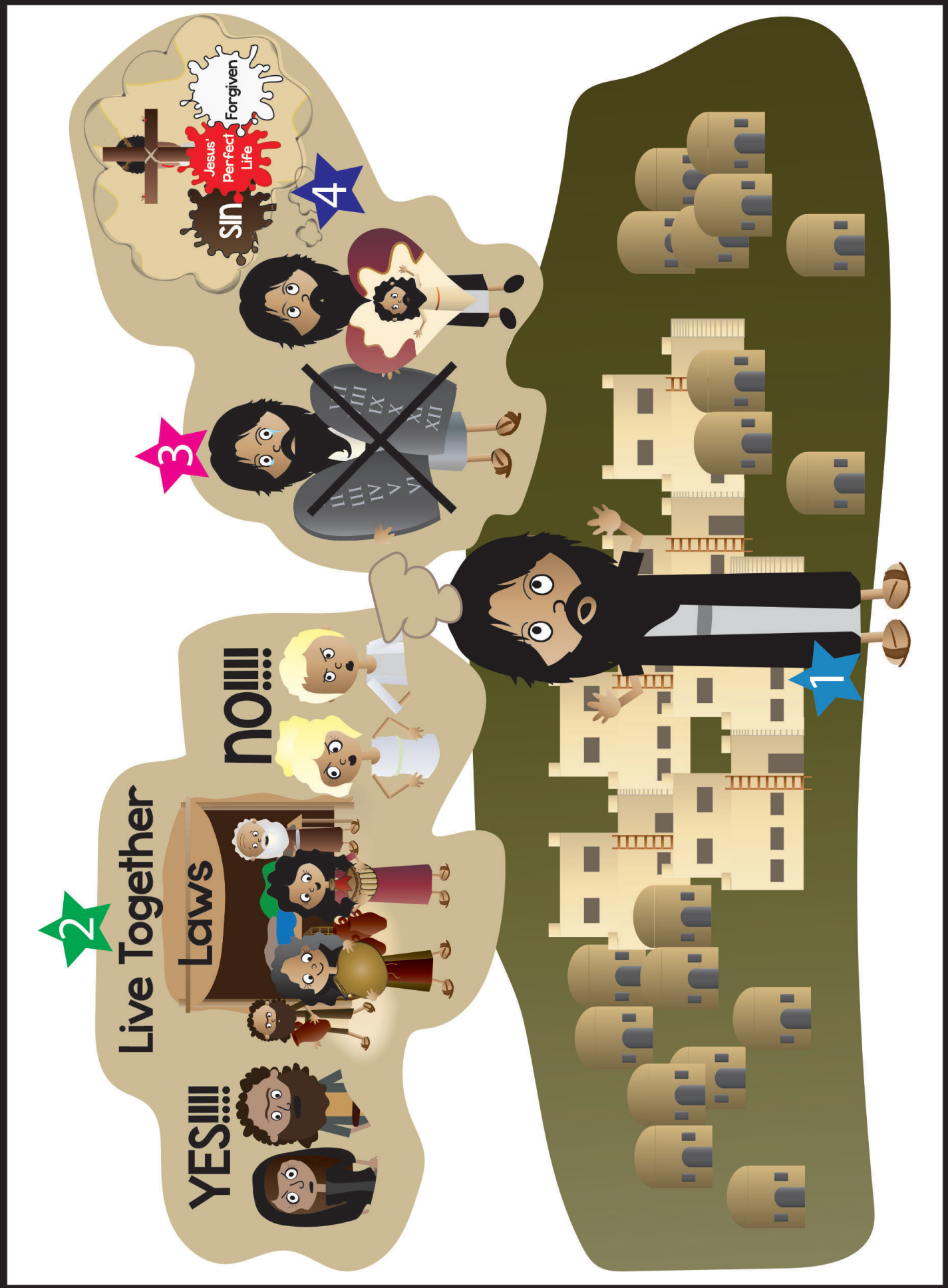

2

Live Together

Laws

YES!!!!

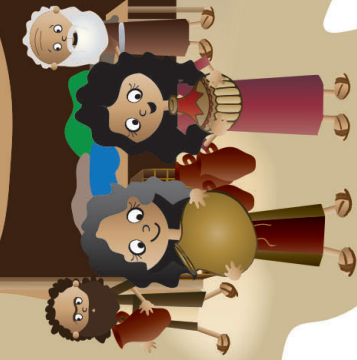

no!!!!

3



4

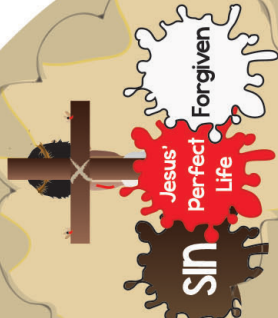

## Story Scene 8

Far away in the city of Corinth, **1** Paul heard about **2** these squabbles.

Paul had come from a Jewish family. He had grown up reading the Bible and learning God's laws.

Paul had tried as hard as he could to keep all of God's laws, but **3** he could never obey them as God required.

Nope, if there was one thing Paul knew, it was only by **4** trusting in Jesus as their Savior that ANYONE can be forgiven of their sins. That was the only way to become one of God's people.

These believers needed to remember this; so, Paul decided to do something about it.

<sup>67</sup> *Can you guess what Paul did?*

**Paul wrote them a letter.**



**Clue Catchers: Can you find Paul trusting in Jesus as his Savior?**

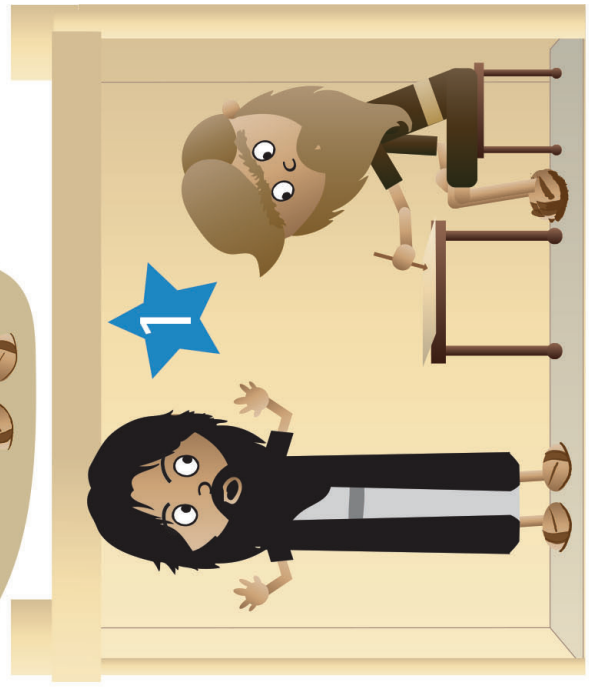
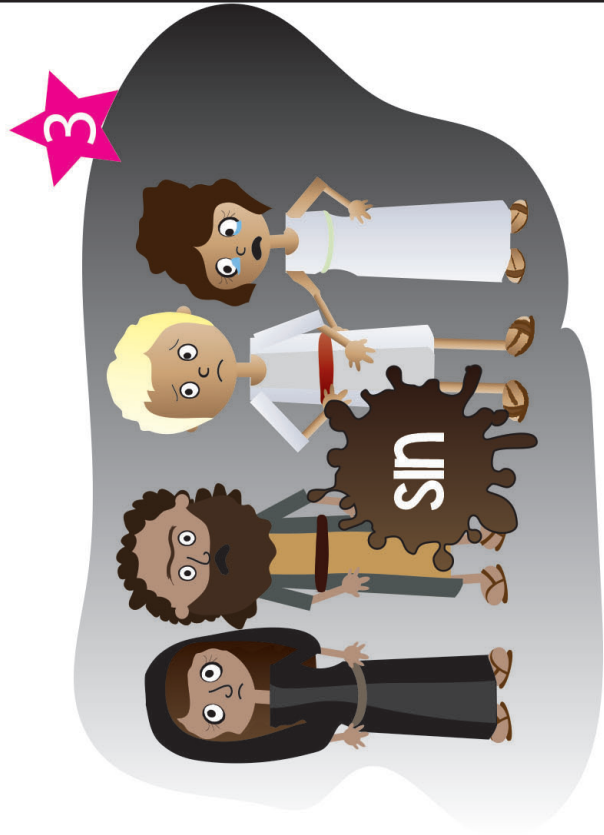
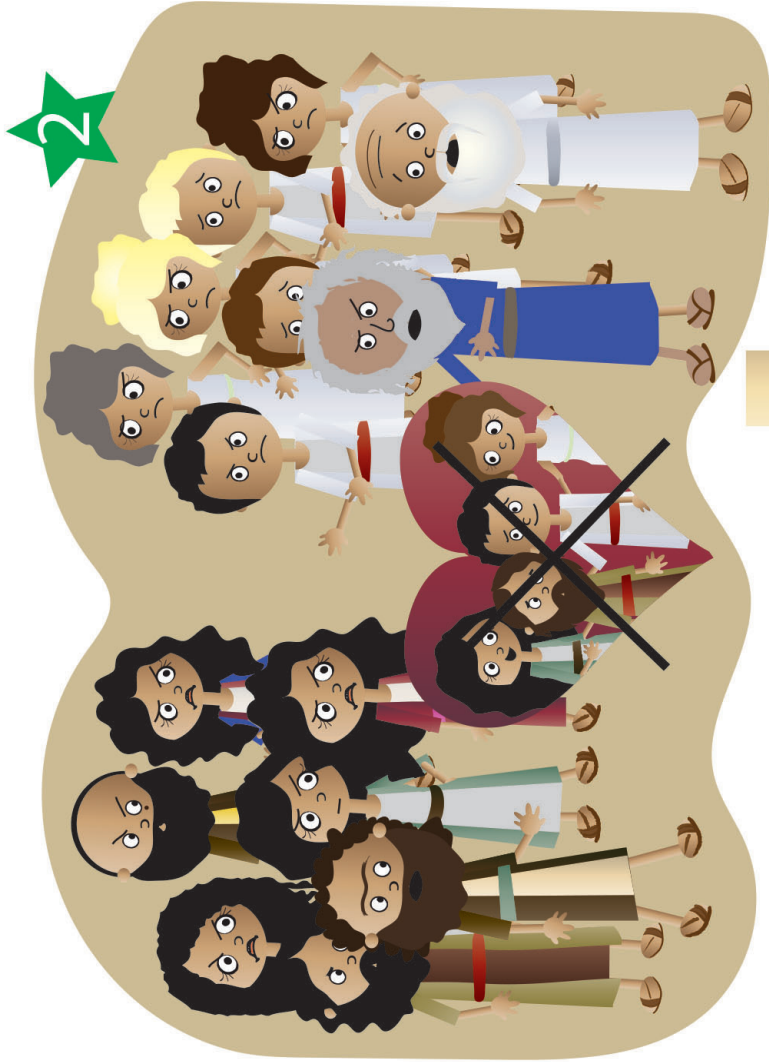

## Story Scene 9

“Help me write to the believers in Rome,” Paul asked  his friend, Tertius. So Tertius got out his scroll and wrote down Paul’s words:

“Dear believers in Rome, I thank God for saving you! I can’t wait for the day when I will get to see you and we can encourage each other in our faith in God! God has given me the job of preaching to all of you--both Jews and Gentiles. One day, I hope to come and preach more of the good news of Jesus to you in Rome, face-to-face.

 I know you are squabbling about who comes from a better family—the Jews or the Gentiles. I know you are squabbling about the Live-Together Laws from God’s Word. But remember:  all people have sinned against God—both Jews and Gentiles. EVERYONE! None of us is righteous. None of us does what is good and never sins. NO ONE! We all deserve God’s punishment.

**Jews:** God may have chosen your family to write down His Word, the Bible. He may have given your family His laws to live by. But you couldn’t obey them all, could you? Nope! You were all law breakers!  You needed a Savior to save you from your sins. Only Jesus could do that for you. Be thankful, not proud!

**And you, Gentiles:** Yes, maybe a lot more people from your Gentile families are trusting in Jesus as their Savior than the Jews these days, but it’s not because Gentiles are better than Jews. It’s only because  God has been kind enough to save you through Jesus, too. Be thankful, not proud!

**You are ALL part of God’s family.**  The Holy Spirit lives in ALL of you. Stop your squibble-squabbling! Love each other like sisters and brothers should! Use the gifts God has given each of you to care for each other and to show others how great God is! Praise God together with me! He gives us everything we need through Jesus, our Savior! -- Paul



**Clue Catchers:** Can you find the picture of Tertius writing down Paul’s letter?

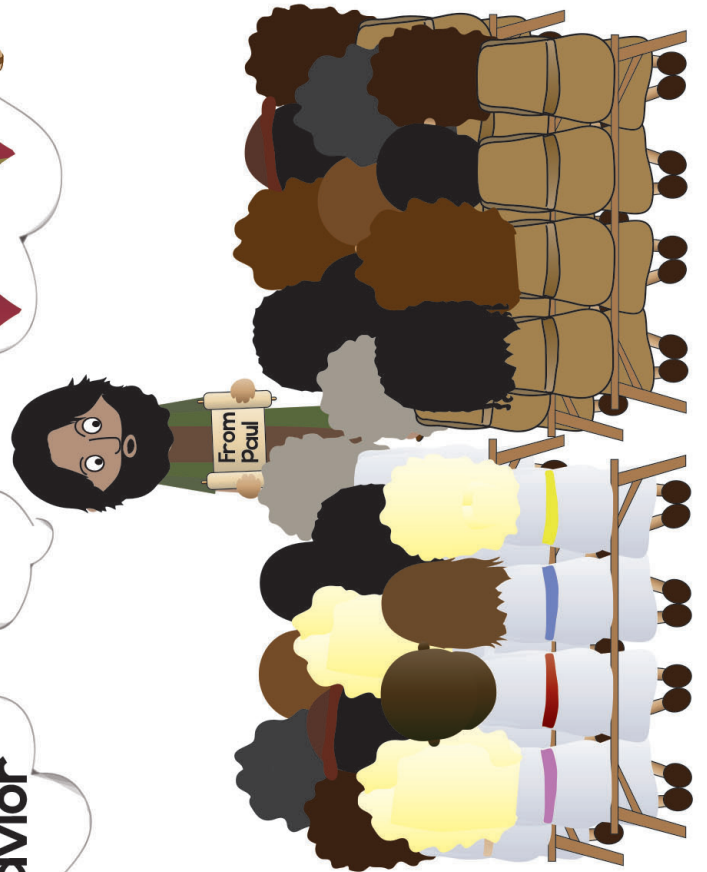
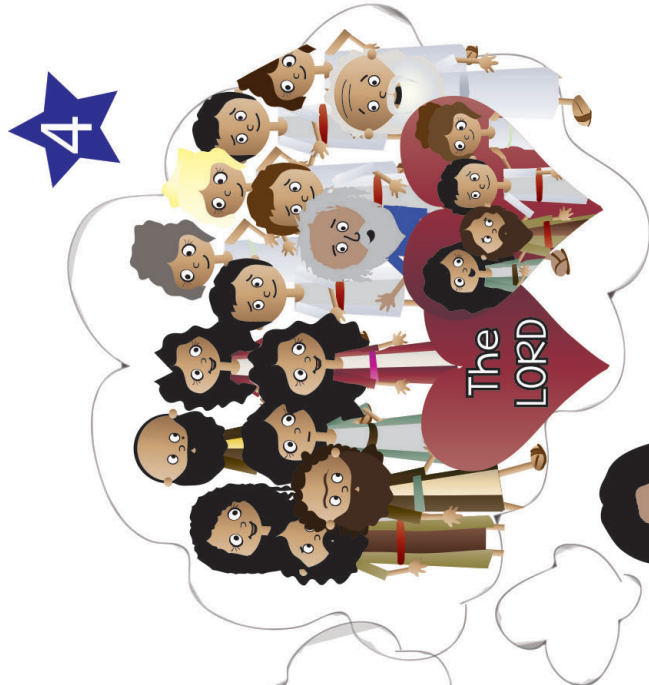
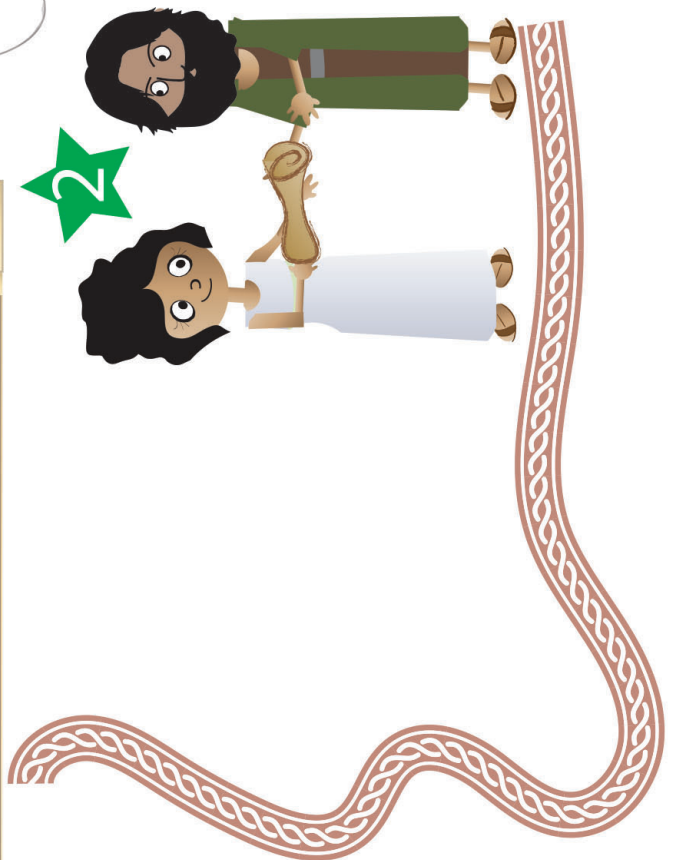
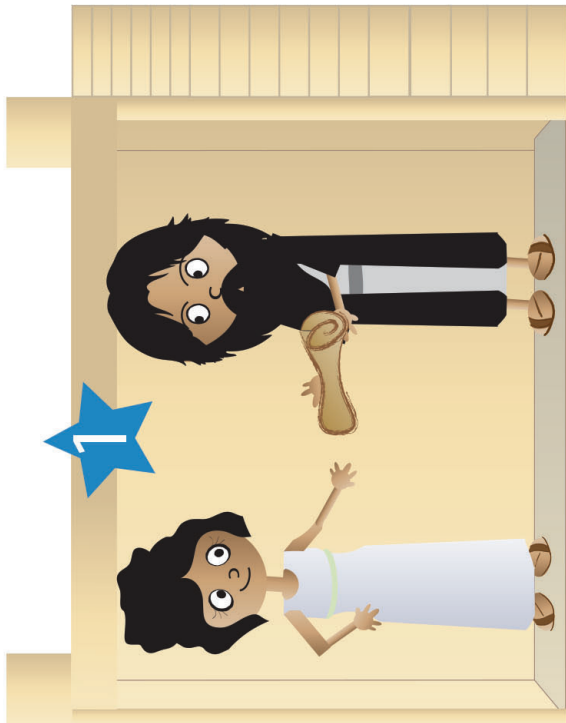

## Story Scene 10

**1** Paul rolled up the letter and gave it to Phoebe to take to the believers in **2** faraway Rome.

What happened when Paul's letter was read to the believers in Rome? We don't really know. The Bible doesn't tell us.

How Paul hoped it would help them remember that **3** they ALL needed Jesus to be their Savior. How he hoped it would stop their squibble-squabbling over who is best and over those LIVE TOGETHER laws!

**4** Paul wanted them to love God and love one another. He wanted them to live out the good news of Jesus together, and share it with others. And I hope that's exactly what they did!



**Clue Catchers:** Can you find the believers gathered together, listening to Paul's letter being read out loud?

**Cracking the Case:** (story wrap-up for Listening Assignments)

It's time to see how we did with our Listening Assignment.

**Detective Dan's Lesson #1 Listening Assignment:**

I need to know:

**To squabble means to argue about something.**

**1. Who were the brothers and sisters who were squabbling?** The believers in Rome.

**2. What were they squabbling about?**

They were squabbling about who was best--the Jews or the Gentiles. And, if all believers should keep the Live Together laws of the Jews.

**For You and Me:**

Just like the believers in Rome, we need to remember that it is only through God's free gift of forgiveness through Jesus that anyone can become one of God's people. This can be His gift to us, too, if we turn away from our sins and trust in Jesus as our Savior.

**Detective Dan's Lesson #2 Listening Assignment:****Our Bible Verse is Ecclesiastes 7:20, 29:**

"There is not a righteous man on earth who does what is right and never sins... This only have I found: God made mankind upright, but men have gone in search of many schemes."

I need to know:

**1. What two kinds of families did the believers in Rome come from?** From Jew and Gentile families.

**2. What did they need to remember that would help them stop squabbling with each other?** That none of them had been righteous. None of them had pleased God by their own, good works. They were saved only through the Savior, Jesus. That's what mattered. Not the Live Together laws.

**For You and Me:**

None of us can ever be good enough to please God. None of us would ever be able to know God or be His people on our own. But the good news is that Jesus did live a perfect life. He offered up His righteous to pay for the sins of God's people--all who turn away from their sins and trust in Jesus as their Savior. God loves to help us do this. Ask Him!

**Detective Dan's Lesson #3 Listening Assignment:**

I found six clues, but two of them are **NOT** in the story. They are: Jews; a jar; Gentiles; fake gods; a bear; and a house.

*Hold each of them up for the children to see as you identify them.*

I need to know:

**1. Which four belong in the story and which two don't?** The Jews; Gentiles; fake gods; and the house belong in the story. The jar and bear were not.

**2. Who thanked God for saving them through Jesus?**

Paul and the believers in Rome all thanked God for saving them through Jesus.

**For You and Me:**

God's people know that they could never live good enough lives to get to be God's people. They thank God for sending Jesus to pay for their sins when He suffered and died on the cross. Jesus can pay for our sins, too, if we turn away from our sins and trust in Him as our Savior. Then we can thank God for saving us and making us His people, too!

**The Gospel** (story wrap-up if NOT using Listening Assignments)**Our Bible Truth is:****What Is the Gospel?**

**It's Salvation through Faith in Jesus Christ...**

**we have all disobeyed God and deserve His punishment!**

Did you know that Paul's letter to those believers in Rome became part of God's Word, the Bible? Millions and millions of people have read his letter to those people in Rome and learned from them. Why, even you are learning from them today! What is the most important thing that we can learn from Paul's letter? It is that all of us are lawbreakers who have chosen to disobey God. We all need to turn away from our sins and trust in Jesus as our Savior. And if we do, God will forgive us and make us His dearly-loved people forever!

*Close in prayer.*



**Closing ACTS Prayer**

- A** God, we praise You for being the good God who hates sin.
- C** We confess that we have all rebelled against You and Your good ways. We have all chosen to live life our own way instead. We need a Savior!
- T** Thank You for not just being good, but for being merciful, too. Thank You for taking the punishment we deserve on Yourself that we might be saved. Thank You for offering us salvation through Jesus, when we repent of our sins and trust Jesus as our Savior.
- S** God, work in our hearts. Help us to turn away from living against You and Your good ways. Help us to trust in Jesus as our Savior. Help us to love You and know You. Help us to obey Your good laws.

In Jesus' name we pray. Amen.



Questions to aid discussion of the key concepts and for use in games

Be familiar with these questions and answers. Look for opportunities to ask questions and discuss their answers, such as while the children work on their coloring pages, as part of their response games, or during play time. Remember: your goal isn't to ask all these questions or only talk to the children about these things. It is to be deliberate in having good conversations with them, however much or little you have.

<p><b>BIG QUESTION</b></p> <p><b>Meaning</b></p> <p><b>Discussion Questions</b></p>	<p>What is the Gospel? It's Salvation through Faith in Jesus Christ!</p> <p>Gospel means "good news." In the Bible, the gospel is the good news that God sent His Son Jesus to save sinners like you and me from the punishment we deserve for our sins. That salvation is ours when we turn from our sins and trust in Jesus as our own Savior.</p> <p><i>choose a few</i></p> <ol style="list-style-type: none"> <li>1. What is the gospel? <i>It's salvation through faith in Jesus!</i></li> <li>2. What does the word "gospel" mean? <i>It means "good news."</i></li> <li>3. Why is the gospel such good news? <i>It tells us how can forgive our sins and make us His people forever!</i></li> <li>4. Who do we need to have faith in? <i>Jesus.</i></li> <li>5. What did Jesus do so we can be saved? <i>He took the punishment for sin when He died on the cross.</i></li> <li>6. What does God want us to turn away from? <i>Our sins.</i></li> <li>7. What does it mean to turn away from our sins? <i>To say "no" to disobeying God and to want to obey Him, instead.</i></li> <li>8. Who can we ask to help us turn away from our sins and trust in Jesus? <i>God! He loves to help us when we ask Him.</i></li> </ol>
<p><b>BIBLE TRUTH</b></p> <p><b>Meaning</b></p> <p><b>Discussion Questions</b></p>	<p>It's Salvation through Faith in Jesus Christ...we have all disobeyed God and deserve His punishment!</p> <p>God is our good Creator. He made us with a spirit so we can know and love Him. He is our good King. He gave us good laws that show us how to love Him and love each other. Life is most wonderful when we know and love God, and we live as He wants us to live.</p> <p>But instead of choosing God and His wonderful way of life, we have all chosen to disobey Him and His good laws. We have chosen to live life our own, selfish way, instead. This is what the Bible calls sin. Because God is good, He hates sin...and He will punish it. And oh, how terrible is God's punishment for sin! It is to live apart from Him and everything good forever! Every single one of us deserve this punishment for our sins.</p> <p>But God isn't only good; He's merciful, too. Merciful means treating us better than we deserve, and that's just exactly how God offers to treat us. Yes, our sins must be punished, but God has chosen to take that punishment on Himself. That's why He sent Jesus, His own dear Son, to earth. Jesus came to take the punishment we deserved for our sins when He suffered and died on the cross. God promises to forgive all who turn away from their sins and trust in Jesus as their Savior. That can even include you and me! Isn't God amazing? How great is God's love for us!</p> <p><i>choose a few</i></p> <ol style="list-style-type: none"> <li>1. Who is our good Creator? <i>God is.</i></li> <li>2. What did He give us so we can know and love Him? <i>A spirit.</i></li> <li>3. What do God's laws show us? <i>They show us how to love God and love others.</i></li> <li>4. Who has chosen to disobey God and His good laws? <i>We all have.</i></li> <li>5. What do we deserve because we have disobeyed God? <i>We deserve His punishment--to be separated from Him and everything good forever.</i></li> <li>6. Who did God send to take the punishment for our sins in our place? <i>He sent Jesus.</i></li> <li>7. What do we need to do if we want to receive God's forgiveness for our sins? <i>We need to turn away from our sins and trust in Jesus as our Savior. God loves to forgive our sins and make us His people when we do.</i></li> </ol>

*Questions to aid discussion of the key concepts and for use in games*

<p><b>THE GOSPEL</b></p>	<p>What is God’s good news for you and me? <i>The gospel!</i> God made all people—including you and me! And He made us to know Him, love Him and obey Him. He’s our good king. But sadly, we have all disobeyed Him and we deserve His punishment. How sad! But God is so merciful that He sent a Savior. His Son, Jesus! Jesus suffered and died on the cross. He offered up His perfect life to God to completely pay for the sins of God’s people. That includes us, when we turn away from our sins and trust in Jesus as our Savior. He loves to help us do this. Ask Him! How good is God to us!</p>
<p><b>BIBLE TRUTH</b> <b>BIBLE VERSE</b></p> <p><b>Meaning</b></p> <p><b>Discussion Questions</b></p> <p><i>choose a few</i></p>	<p>“There is not a righteous man on earth who does what is right and never sins... This only have I found: God made mankind upright, but men have gone in search of many schemes.” --Ecclesiastes 7:20,29</p> <p><b>Learn a Little:</b> “There is not a righteous man on earth who does what is right and never sins.”</p> <p>In the beginning, God created the heavens and the earth. He created it all good. Oh, how wonderful was the love that those first people had for God! Oh, how wonderful it was to know Him and to obey Him! The big Bible word for loving God and living His good way is “righteous.”</p> <p>But that’s not the way things are now. Sadly, we all have chosen to disobey God. We want to do things our own way, not God’s good way. We make sneaky schemes and plan how we can get what we want or do what we want, instead of what God wants. Our hearts are not full of love for God or for others as they should be.</p> <p>No one is righteous anymore. No one, that is, except Jesus, God’s Son. God sent Jesus live a perfect, righteous life and give it as the payment for our sins. We can have Jesus’ righteousness and become one of God’s people, when we turn away from our sins and trust in Jesus as our Savior. God loves to help us do this. Ask Him!</p> <ol style="list-style-type: none"> <li>1. What was the world like in the beginning when God first created it? <i>It was good--all good.</i></li> <li>2. What did the first people (Adam and Eve) enjoy in the beginning? <i>They enjoyed knowing, loving and obeying God perfectly. They enjoyed being righteous.</i></li> <li>3. What is the big Bible word for loving God and living His good way? <i>Righteous.</i></li> <li>4. Who have all people chosen to disobey? <i>God and His good ways.</i></li> <li>5. Who do we want to please instead of God? <i>Ourselves.</i></li> <li>6. No one is righteous anymore, except for one person. Who is that? <i>Jesus.</i></li> <li>7. What was special about the life Jesus lived? <i>It was perfect. He never, ever disobeyed God.</i></li> <li>8. What did Jesus use His perfect life to do? <i>Jesus gave it up as the perfect payment for our sins. He wanted to save us so we could become God’s people.</i></li> <li>9. How can we be forgiven our sins and become one of God’s people? <i>By turning away from our sins and trusting in Jesus as our Savior.</i></li> </ol>
<p><b>BIBLE STORY</b></p> <p><b>Discussion Questions</b></p> <p><i>choose a few</i></p>	<p><b>The Case of the Squabbling Brothers and Sisters</b></p> <p><i>choose a few</i></p> <ol style="list-style-type: none"> <li>1. Who were the squabbling sisters and brothers? <i>God’s people in Rome.</i></li> <li>2. What were they arguing about? <i>They were arguing about who was best: the Jews or the Gentiles. They were arguing about if believers should keep the little rules of the Jews.</i></li> <li>3. How did Jews grow up? <i>They grew up as part of Abraham’s family. They grew up learning God’s Word and trying to keep all of the big and little rules of God’s law.</i></li> <li>4. How did Gentiles grow up? <i>They grew up worshipping other gods. They didn’t know God’s Word or keep the big and little rules of God’s laws.</i></li> <li>5. Who found out the believers in Rome were squabbling? <i>Paul did.</i></li> <li>6. Did Paul grow up as a Jew or a Gentile? <i>A Jew.</i></li> <li>7. How did Paul try to please God as he grew up as a Jew? Could he do it? <i>By keeping all of the big and little rules of God’s law. No, he could never keep all of God’s law, no matter how hard he tried.</i></li> <li>8. What did Paul learn was the only way that he (or anyone else) could be made right with God? <i>Only through trusting Jesus as his Savior.</i></li> <li>9. What did Paul remind the believers in Rome who had been Jews? <i>They weren’t better because they had grown up learning God’s Word and trying to keep His laws. They were still sinners who needed Jesus to be their Savior.</i></li> <li>10. What did Paul remind the believers in Rome from Gentile families? <i>To thank God for offering them salvation through Jesus.</i></li> </ol>

CAN YOU GUESS BIBLE TRUTH 2:

What's the Gospel?

It's Salvation through Faith in Jesus Christ...

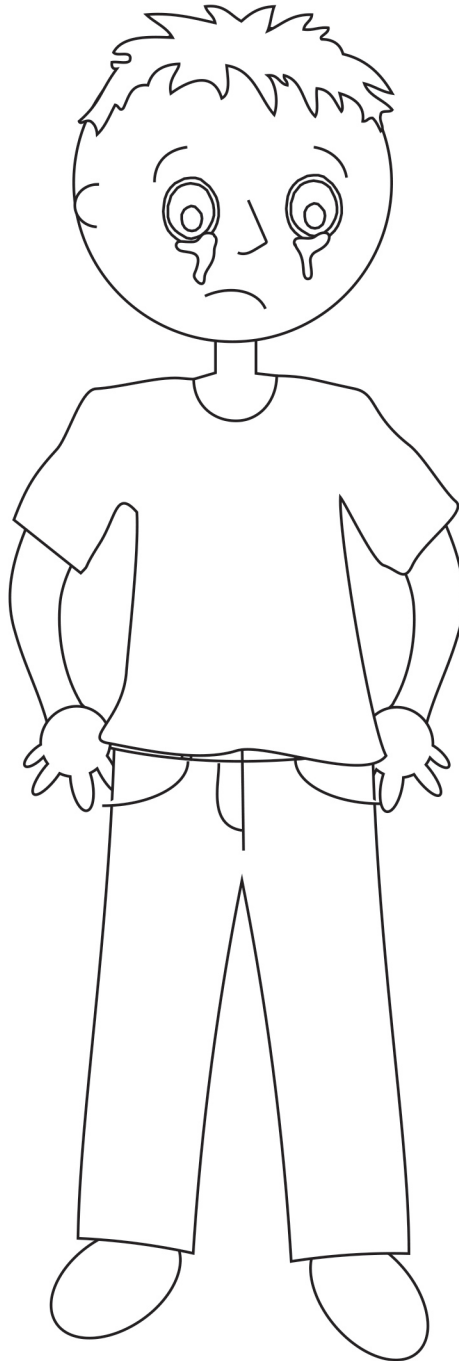

We have all disobeyed God and deserve His

----- !

HINT: "What we deserve when we do something wrong on purpose."

It's a sad word that rhymes with "compliment."

# Deep Down Detective Devotion: Unit 3, Bible Truth 2, Lesson 1



**Big Question 3:** What is the Gospel?

**Answer:** It's Salvation through Faith in Jesus Christ... We have all disobeyed God and deserve His punishment!

## Bible Truth 2 Meaning

God is our good Creator. He made us with a spirit so we can know and love Him. He is our good King. He gave us good laws that show us how to love Him and love each other. Life is most wonderful when we know and love God, and we live as He wants us to live. But instead of choosing God and His wonderful way of life, we have all chosen to disobey Him and His good laws. We have chosen to live life our own, selfish way, instead. This is what the Bible calls sin. Because God is good, He hates sin...and He will punish it. And oh, how terrible is God's punishment for sin! It is to live apart from Him and everything good forever! Every single one of us deserve this punishment for our sins. But God isn't only good; He's merciful, too. Merciful means treating us better than we deserve, and that's just exactly how God offers to treat us. Yes, our sins must be punished, but God has chosen to take that punishment on Himself. That's why He sent Jesus, His own dear Son, to earth. Jesus came to take the punishment we deserved for our sins when He suffered and died on the cross. God promises to forgive all who turn away from their sins and trust in Jesus as their Savior. That can even include you and me! Isn't God amazing? How great is God's love for us!

## How do I know this is true? The Bible tells me so!

"Surely there is not a righteous man on earth who does good and never sins... See, this alone I found, that God made man upright, but they have sought out many schemes." --- Ecclesiastes 7:20,29, ESV

## Some Questions for You

1. Who is our good Creator? *God is.*
2. Who has chosen to disobey God and His good laws? *We all have.*
3. What do we deserve because we have disobeyed God? *We deserve His punishment--to be separated from Him and everything good forever.*
4. Who did God send to take the punishment for our sins in our place? *He sent Jesus.*
5. What do we need to do if we want to receive God's forgiveness for our sins? *We need to turn away from our sins and trust in Jesus as our Savior. God loves to forgive our sins and make us His people when we do.*

## Let's Pray!

- A** God, we praise You for being the good God who hates sin.
- C** We confess that we have all rebelled against You and Your good ways. We have all chosen to live life our own way instead. We need a Savior!
- T** Thank You for not just being good, but for being merciful, too. Thank You for taking the punishment we deserve on Yourself that we might be saved. Thank You for offering us salvation through Jesus, when we repent of our sins and trust Jesus as our Savior.
- S** God, work in our hearts. Help us to turn away from living against You and Your good ways. Help us to trust in Jesus as our Savior. Help us to love You and know You. Help us to obey Your good laws. In Jesus' name we pray, Amen.

## Let's Sing about What We're Learning!

**Big Q & A 3 Song** from *Deep Down Detectives ESV Songs 3, track 12*

(sung to the tune of "Oh, My Darlin' Clementine")

What's the gospel?  
What's the gospel?  
Can you tell me what it is?  
It's salvation through faith in Jesus,  
That's what the gospel is. (repeat)

**Big Question 3 Action Rhyme Song** from *Deep Down Detectives ESV Songs 3, track 13*

**Refrain:**

What is the gospel? G-O-S-P-E-L?	"G" is for God, our good King and Creator, O, we should obey Him, but instead we're disobeyers, So S, we need a Savior to save us from our sins, That Savior is Jesus, who "P" took the punishment.	Yes, Jesus died upon the cross, the perfect sacrifice, Then on Day Three, He rose again To prove He'd won the fight,  And now "E" everyone who repents and believes in Him, He gives "E-L" eternal life: forever life with Him. <i>Refrain</i>
-------------------------------------	--	---

Go to the *Deep Down Detectives Parent Resources for Unit 3* to get the Bible story and many more resources and songs for this unit at [praisefactory.org](http://praisefactory.org)

DDD BQ 3 BT 2 L1 Coloring Sheet/Take Home pg2

**“There is not a righteous man on earth  
who does what is right and never sins...**



**This only have I found: God made mankind upright,  
but men have gone in search of many schemes.”**

**Ecclesiastes 7:20,29**

## Deep Down Detective Devotion: Unit 3, Bible Truth 2, Lesson 2



**Big Question 3:** What is the Gospel?

**Answer:** It's Salvation through Faith in Jesus Christ... We have all disobeyed God and deserve His punishment!

**How do I know this is true? The Bible tells me so:**

"There is not a righteous man on earth who does what is right and never sins... This only have I found: God made mankind upright, but men have gone in search of many schemes."--- Ecclesiastes 7:20,29

**Learn a Little:** "There is not a righteous man on earth who does what is right and never sins."

**Meaning:**

In the beginning, God created the heavens and the earth. He created it all good. Oh, how wonderful was the love that those first people had for God! Oh, how wonderful it was to know Him and to obey Him! The big Bible word for loving God and living His good way is "righteous."

But that's not the way things are now. Sadly, we all have chosen to disobey God. We want to do things our own way, not God's good way. We make sneaky schemes and plan how we can get what we want or do what we want, instead of what God wants. Our hearts are not full of love for God or for others as they should be.

No one is righteous anymore. No one, that is, except Jesus, God's Son. God sent Jesus live a perfect, righteous life and give it as the payment for our sins. We can have Jesus' righteousness and become one of God's people, when we turn away from our sins and trust in Jesus as our Savior. God loves to help us do this. Ask Him!

**Some Questions for You**

1. What was the world like in the beginning when God first created it? *It was good--all good.*
2. What did the first people (Adam and Eve) enjoy in the beginning? *They enjoyed knowing, loving and obeying God perfectly. They enjoyed being righteous.*
3. What is the big Bible word for loving God and living His good way? *Righteous.*
4. Who have all people chosen to disobey? *God and His good ways.*
5. Who do we want to please instead of God? *Ourselves.*
6. No one is righteous anymore, except for one person. Who is that? *Jesus.*
7. What was special about the life Jesus lived? *It was perfect. He never, ever disobeyed God.*
8. What did Jesus use His perfect life to do? *Jesus gave it up as the perfect payment for our sins. He wanted to save us so we could become God's people.*
9. How can we be forgiven our sins and become one of God's people? *By turning away from our sins and trusting in Jesus as our Savior.*

**Let's Pray!**

- A** God, we praise You for being the good God who hates sin.
- C** We confess that we have all rebelled against You and Your good ways. We have all chosen to live life our own way instead. We need a Savior!
- T** Thank You for not just being good, but for being merciful, too. Thank You for taking the punishment we deserve on Yourself that we might be saved. Thank You for offering us salvation through Jesus, when we repent of our sins and trust Jesus as our Savior.
- S** God, work in our hearts. Help us to turn away from living against You and Your good ways. Help us to trust in Jesus as our Savior. Help us to love You and know You. Help us to obey Your good laws. In Jesus' name we pray, Amen.

**Let's Sing Our Bible Verse!**

**There Is Not a Righteous Man: Ecclesiastes 7:20,29** from *Deep Down Detectives NIV Songs 3, track 20*

There is not a righteous man on earth,  
Who does what is right and never sins.  
This only have I found;  
God made mankind upright,  
But men have gone in search of many schemes.  
Ecclesiastes Seven: twenty and twenty-nine.

*Go to the Deep Down Detectives Parent Resources for Unit 3 to get the Bible story and many more resources and songs for this unit at [praisefactory.org](http://praisefactory.org)*



Which four of these clues belong in our story? Which two do not? Put an X in the boxes of the four that belong.

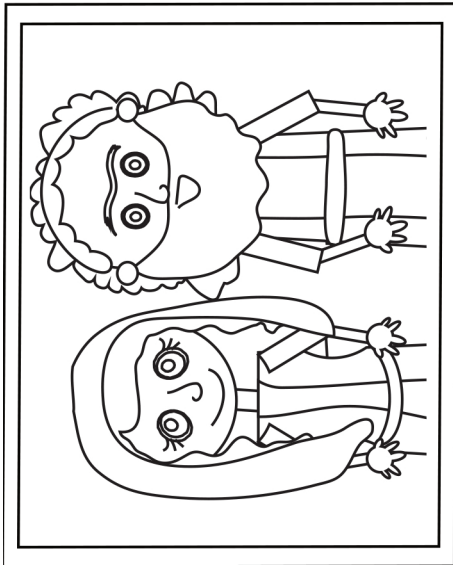

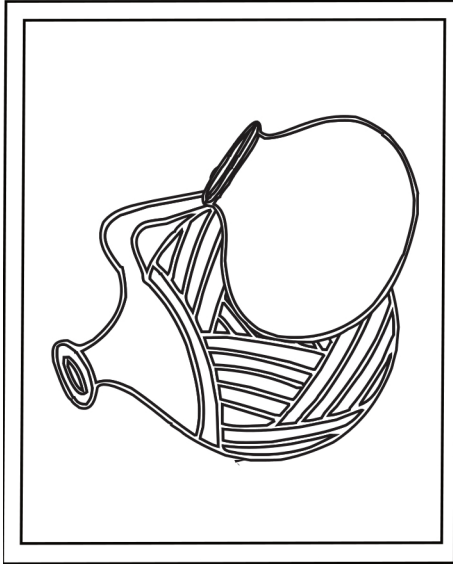

Jews



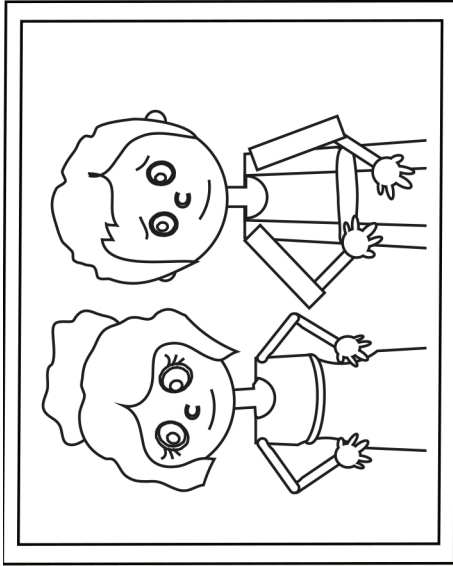

A Jar

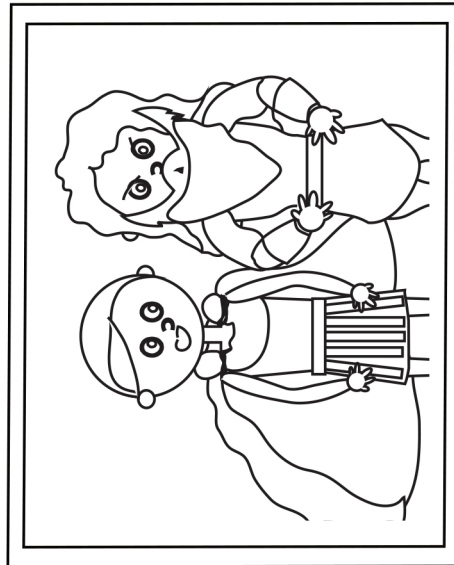



Gentiles

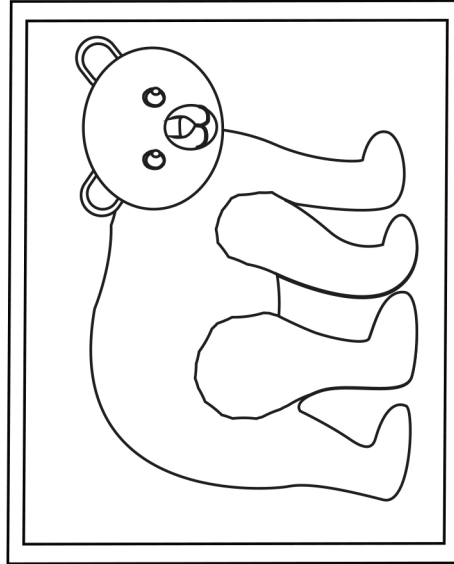

Fake Gods

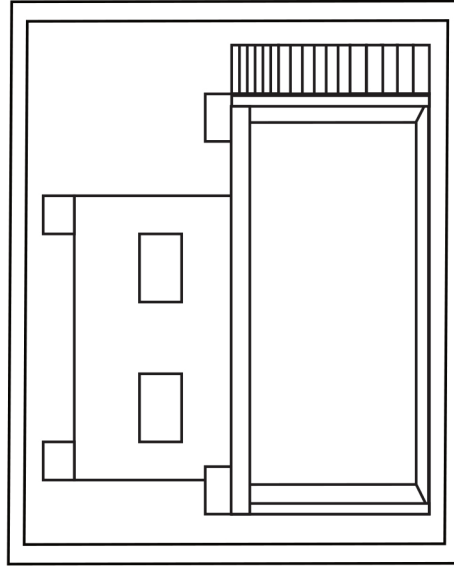

A Bear



A House

Answer: The Jews; the Gentiles; the fake gods; and, the house belong. The jar and the bear do not.

## Deep Down Detective Devotion: Unit 3, Bible Truth 2, Lesson 3



**Big Question 3:** What is the Gospel?

**Answer:** It's Salvation through Faith in Jesus Christ... We have all disobeyed God and deserve His punishment!

### Bible Truth 2 Meaning

God is our good Creator. He made us with a spirit so we can know and love Him. He is our good King. He gave us good laws that show us how to love Him and love each other. Life is most wonderful when we know and love God, and we live as He wants us to live.

But instead of choosing God and His wonderful way of life, we have all chosen to disobey Him and His good laws. We have chosen to live life our own, selfish way, instead. This is what the Bible calls sin. Because God is good, He hates sin...and He will punish it. And oh, how terrible is God's punishment for sin! It is to live apart from Him and everything good forever! Every single one of us deserve this punishment for our sins.

But God isn't only good; He's merciful, too. Merciful means treating us better than we deserve, and that's just exactly how God offers to treat us. Yes, our sins must be punished, but God has chosen to take that punishment on Himself. That's why He sent Jesus, His own dear Son, to earth. Jesus came to take the punishment we deserved for our sins when He suffered and died on the cross. God promises to forgive all who turn away from their sins and trust in Jesus as their Savior. That can even include you and me! Isn't God amazing? How great is God's love for us!

### How do I know this is true? The Bible tells me so!

"There is not a righteous man on earth who does what is right and never sins... This only have I found: God made mankind upright, but men have gone in search of many schemes."--- Ecclesiastes 7:20,29

### Some Questions for You

Our six case clues were: Jews; a jar; Gentiles; fake gods; a bear; and a house.

1. Which four belong in our story? *The Jews; Gentiles; fake gods; and the house.*

2. Who thanked God for saving them through Jesus?

*Paul and the believers in Rome all thanked God for saving them through Jesus.*

3. What is the big Bible word for loving God and living His good way? *Righteous.*

4. What was special about the life Jesus lived? *It was perfect. He never, ever disobeyed God. He was righteous.*

5. What did Jesus use His perfect life to do? *Jesus gave it up as the perfect payment for our sins.*

6. How can we be forgiven our sins and become one of God's people? *By turning away from our sins and trusting in Jesus as our Savior.*

### Let's Pray!

**A** God, we praise You for being the good God who hates sin.

**C** We confess that we have all rebelled against You and Your good ways. We have all chosen to live life our own way instead. We need a Savior!

**T** Thank You for not just being good, but for being merciful, too. Thank You for taking the punishment we deserve on Yourself that we might be saved. Thank You for offering us salvation through Jesus, when we repent of our sins and trust Jesus as our Savior.

**S** God, work in our hearts. Help us to turn away from living against You and Your good ways. Help us to trust in Jesus as our Savior. Help us to love You and know You. Help us to obey Your good laws. In Jesus' name we pray, Amen.

### Let's Praise God Right Now!

**Big Q & A 3 Hymn: And Can It Be** from *Deep Down Detectives ESV Songs 3, track 17*

#### Refrain

Amazing love, how can it be?

That thou, my God, should die for me?

Amazing love, how can it be?

That thou, my God, should die for me?

Words: Charles Wesley Music: Thomas Campbell

**Big Question 3 Praise Song: I Have Decided to Follow Jesus** from *Deep Down Detectives ESV Songs 3, track 18*

I have decided to follow Jesus,

I have decided to follow Jesus,

I have decided to follow Jesus,

No turning back, no turning back.

Go to the *Deep Down Detectives Parent Resources for Unit 3* to get the Bible story and many more resources and songs for this unit at [praisefactory.org](http://praisefactory.org)  
DDD BQ 3 BT 2 L3 Coloring Sheet/Take Home pg2

# Jesus Made Our Friendship with God

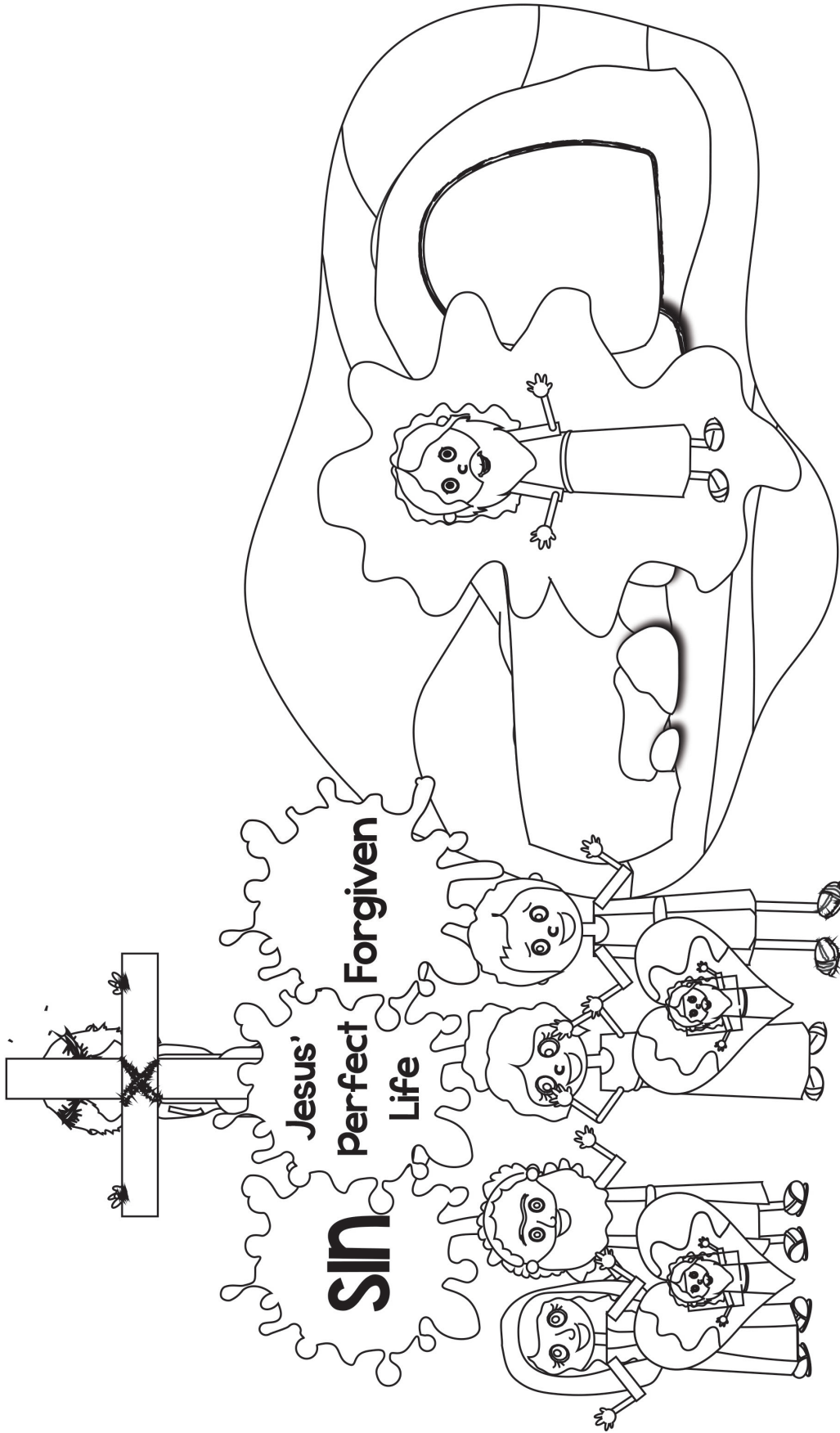

What is the Gospel? It's Salvation through Faith in Jesus Christ...we have all disobeyed God and deserve His punishment!

Did you know that Paul's letter to those believers in Rome became part of God's Word, the Bible? Millions and millions of people have read his letter to those people in Rome and learned from them. Why, even you are learning from them today! What is the most important thing that we can learn from Paul's letter? It is that all of us are lawbreakers who have chosen to disobey God. We all need to turn away from our sins and trust in Jesus as our Savior. And if we do, God will forgive us and make us His dearly-loved people forever!



# **DEEP DOWN DETECTIVES**

**Fundamentals:**

**Unit 3, Bible Truth 3**



**What Is the Gospel?**

**It's Salvation through Faith**

**in Jesus Christ...**

**God Sent Jesus to Pay**

**for the Sins of God's People!**



---

## Unit 3: The Good News of God, the Gospel

---

### UNIT OVERVIEW

Gospel means “good news.” In the Bible, the gospel is the good news that God sent His Son Jesus to save sinners like you and me from the punishment we deserve for our sins. That salvation is ours when we turn from our sins and trust in Jesus as our own Savior. Now that is good news indeed!

In this unit we will learn four ways the gospel is such good news.

### UNIT BIBLE VERSE: John 3:16

“For God so loved the world that he gave his one and only Son, that whoever believes in him shall not perish but have eternal life.”

### BIG QUESTION UNDER INVESTIGATION: What Is the Gospel?

**ANSWER:** It’s Salvation through Faith in Jesus Christ!

#### OPTIONAL Big Question 3 INTRODUCTION LESSON (Use Hide ‘n’ Seek Kids Unit 3 Material)

Story: The Case of the Stranger’s Very Good News *Acts 8:1-8*

Bible Verse: John 3:16

#### BIBLE TRUTH 1: God Made Us and We Should Obey Him (3 Lessons Available)

Story: The Case of the God Who Was Different *Acts 17:16-33*

Bible Verse: Psalm 100:1-4

#### BIBLE TRUTH 2: We Have All Disobeyed God and Deserve His Punishment (3 Lessons Available)

Story: The Case of the Squabbling Brothers and Sisters *Romans*

Bible Verse: Ecclesiastes 7:20,29

#### ➔ BIBLE TRUTH 3: God Sent Jesus to Pay for the Sins of God’s People (3 Lessons Available)

Story: The Case of the Savior, from Start to Finish *Genesis, The Gospels*

Bible Verse: Psalm 119:18,72-73

#### BIBLE TRUTH 4: God Saves All Who Repent of Their Sins and Trust in Jesus as Their Savior

(3 Lessons Available)

Story: The Case of Cruddy Crete *Titus*

Bible Verse: Mark 1:15

---

## Deep Down Detectives NIV Songs 3 Track Numbers

---

This is a listing of all songs mentioned in the unit curriculum. You may or may not choose to use all of the songs. They are listed in easy-reference order--NOT in the order used in the curriculum.

You may choose to simply burn a CD/load them onto an mp3 device in this order. Or, you may want to do what we do: choose the songs we want to use and create a play list of them in that order. Then, we burn a CD/upload the play list onto an mp3 device. A teacher only has to click forward to the next song, instead of hunting for the right track. The track number have been included as part of the title of each song, so teachers will still have a reference to the track number listed in the curriculum (same as those listed below), even if you change the order on your customized play list.

### SONGS USED EVERY UNIT OF THE CURRICULUM

- 1 The Classroom Song v.1
- 2 The Classroom Song v.2
- 3 The Classroom Song v.3
- 4 The Classroom Song v.4
- 5 Deep Down Detectives Theme Song
- 6 The Classroom Rules Song
- 7 Let's Pray Song
- 8 The Big Question Box Song
- 9 The Bible Chant Song
- 10 ACTS Prayer Song (Short Version)
- 11 ACTS Prayer Song (Full Version)

#### Why the Extra Songs?

Deep Down Detectives is a curriculum used by a wide age-span of kids. Sometimes one of the other songs is a better fit for your kids. Or, you may simply want to teach them more songs on the same Bible Truth. Use as many or as few as you want.

### UNIT 3: GOD'S GOOD NEWS, THE GOSPEL

- 12 Big Q & A 3 Song
- 13 Big Question 3 Song: What's the Gospel?
- 14 Big Question 3 Bible Verse Song: For God So Loved the World John 3:16
- 15 *Extra Big Question 3 Bible Verse Song: For God So Loved the World John 3:16 (version 2)*
- 16 *Extra Big Question 3 Bible Verse Song: For God So Loved the World John 3:16 (version 3)*
- 17 Big Question 3 Hymn: And Can It Be, v.1 Refrain
- 18 Big Question 3 Praise Song: I Have Decided to Follow Jesus

#### What Is the Gospel?

#### Salvation through Faith in Christ...

#### Bible Truth 1: God Made Us and We Should Obey Him

- 19 Bible Verse: Shout for Joy Psalm 100:1,2

#### Bible Truth 2: We Have All Disobeyed God and Deserve His Punishment

- 20 Bible Verse: There Is Not a Righteous Man Ecclesiastes 7:20,29

#### Bible Truth 3: God Sent Jesus to Pay for the Sins of God's People!

- 21 Bible Verse: He Was Pierced Isaiah 53:5

#### Bible Truth 4: God Saves All Who Repent of Their Sins and Trust in Jesus

- 22 Bible Verse: The Time Has Come Mark 1:15
- 23 *Extra Bible Verse: Help Us, O God, Our Savior Psalm 79:9*



**Unit 3: The Good News of God, the Gospel**

**Unit Big Question (and Answer):** What Is the Gospel? It's Salvation through Faith in Jesus Christ!

**Unit Bible Verse:** "For God so loved the world that he gave his one and only Son, that whoever believes in him shall not perish but have eternal life." John 3:16

**Bible Truth 3 Concept: Salvation through Faith in Jesus Christ...God Sent Jesus to Pay for the Sins of God's People!**

What a mess we have made in God's good world! God is our good Maker and King, yet we have all chosen to disobey Him. Because God is good, He hates sin and He is right to punish our sins. We certainly deserve it! The punishment for sins is death--being separated from God and all His goodness forever. How sad!

But God is not only good. He is also very merciful. He treats us better than we deserve. That's why God, Himself, made a way for us to be forgiven our sins and to become His people. God sent His own, dear Son, Jesus to live the perfect life of love and obedience that we should live, but never do. On the cross, Jesus offered His perfect life to God as the full payment for sin for all who turn away from their sins and trust in Him as their Savior. Jesus suffered and died in our place. Then on the third day, Jesus rose up from the dead, showing that He had really beaten sin and death! Jesus can be our Savior, too, when we turn away from our sins and trust in Him as our Savior.

**Bible Truth 3 Bible Verse: Isaiah 53:5-6**

"But he was pierced for our transgressions, he was crushed for our iniquities; the punishment that brought us peace was upon him, and by his wounds we are healed. We all, like sheep, have gone astray, each of us has turned to his own way; and the LORD has laid on him the iniquity of us all."

**Learn a Little:** "The punishment that brought us peace was upon him."

**Meaning**

God is our good King and Creator and we should love and obey Him. But the sad news is that we all choose to disobey Him...and we all deserve His punishment.

Yes, we deserve His punishment, but God has loved us so much that He sent His Son, Jesus to take the punishment that we deserve instead. Jesus lived a perfect life and chose to give it up to pay for our sins. On the cross He suffered and died. He was pierced with nails in His hands and feet. He was pierced in His side with a sword. He took all of the punishment that we deserve from God for our sins so that we could be forgiven. Jesus made the way for us to have peace with God by suffering in our place.

Who did Jesus do this for? It is God's free gift to all who put their trust in Jesus as their Savior and choose to live for Him. This gift can be for you, too! Ask God to help you. He loves to answer this prayer!

**Bible Truth 3 ACTS Prayer**

- A** God, we praise You for being the good Creator and King of the world.
- C** God, we confess rebelling against You and Your good ways. Too many times we choose to live life our own way instead of Yours. We need a Savior!
- T** Thank You for being our good Creator and King. Thank You for making everything in the world for Your good purposes. Thank You for being so merciful to us! Thank You for offering us salvation through Jesus, when we repent of our sins and trust Jesus as our Savior.
- S** God, work in our hearts, helping us to turn away from disobeying You. Help us to trust in Jesus as our Savior. Help us to joyfully obey You, as is best for us and brings You glory. In Jesus' name we pray. Ame

**Bible Truth 3 Story****The Case of the Savior, from Start to Finish**

*Genesis; The Gospels*

**Songs Used in Bible Truth 3**

Big Question 3 Bible Verse Song: For God So Loved the World John 3:16

*Extra Big Question 3 Bible Verse Song: For God So Loved the World John 3:16 (version 2)*

*Extra Big Question 3 Bible Verse Song: For God So Loved the World John 3:16 (version 3)*

Big Question 3 Hymn: And Can It Be, v.1 Refrain

Big Question 3 Praise Song: I Have Decided to Follow Jesus

Bible Truth 3 Bible Verse Song: He Was Pierced Isaiah 53:5

**The Case of the Savior, from Start to Finish***Genesis, The Gospels***Story-telling Tips**

Ahead of time:

1. Read the Bible verses and story. Pray!
2. Practice telling story with expression. Look for words that might be new to your children. Plan to explain the meaning of them to the children. The numbers in the story correspond to elements of the picture. Practice pointing to the pictures as you read the story. Shorten the story, if necessary, for your child/group of children.
3. If desired, choose a listening assignment for the children (listed below). Listening with a purpose helps the children keep focused and glean more from the story. The three, different assignments allow you to re-tell the story three times with fresh purpose. Answers to the listening assignments are found at the end of the story.

During your presentation:

1. If you are telling the story to a group of children, maintain as much eye contact as possible as you tell the story. Tell the story with enthusiasm and expression. Take time to show each story scene to the children as you tell it. Use the cue numbers in the story to highlight corresponding parts of the picture as you tell the story.
2. The Clue Catcher question at the bottom of each scene helps the children keep engaged with the story.
3. Include the children in your story with a few questions about what they think will happen or words/concepts that might be new to them.
4. Watch the kids for signs that their attention span has been reached. Shorten, if necessary.
5. At end of the story, repeat the listening assignment question and ask for answers. Close in prayer.

**INTRODUCTION/ LISTENING ASSIGNMENTS (Optional)**

**“Our story is called: The Case of the Savior, from Start to Finish. Here is your listening assignment... “**  
*(optional)*

**Detective Dan’s Lesson #1 Listening Assignment:****I need to know:**

1. Who was the Savior?
2. When did the promise of a Savior start? When did it finish?

**Detective Dan’s Lesson #2 Listening Assignment:****Our Bible Verse is Isaiah 53:5-6**

“But he was pierced for our transgressions, he was crushed for our iniquities; the punishment that brought us peace was upon him, and by his wounds we are healed. We all, like sheep, have gone astray, each of us has turned to his own way; and the LORD has laid on him the iniquity of us all.”

**I need to know:**

Transgressions and iniquities are other words for sin.

1. Whose transgressions and iniquities deserved God’s punishment in our story?
2. Who came to take God’s punishment for them?

**Detective Dan’s Lesson #3 Listening Assignment:**

I found six clues, but two of them are NOT in the story.

They are: a tree; a lamp; a garden; a cave grave; a bed; and, a man named Abraham.

Hold each of them up for the children to see as you identify them.

**I need to know:**

1. Which four belong in the story and which two don’t?
2. Which one did the Savior use to prove He had won? What do we thank Him for beating?

**Read the assignment questions, THEN SAY,**

“Ok, Deep Down Detectives! Put on your best listening ears and see if you can hear the answers to Detective Dan’s questions. When I finish telling the story, we will see if we can answer all the questions.”

*Read the Bible Truth story, answer questions, present the gospel and lead in prayer.  
Answers to questions; the gospel; and, ACTS prayer are included with the story text.*



## Story Scene 1

Back in the very beginning,  God created our world.

Heavens and earth.  
Sky and seas,  
Mountains and valleys,  
Flowers and trees,  
Birds and fish and animals, too,  
And best of all, God made people,  
Like me and you.

And it was all good. VERY good.

But why were **PEOPLE** the best of all that God created, back in the very beginning? It's because He created people with something that no other earth creature had: a  living spirit that could know and love Him. We could have a special closeness to God that no one else could enjoy!

I'm sure it's very fine to be a fast horse galloping across a grassy field; or, a proud eagle soaring on the wind high up in the sky. I'm sure it would be marvelous to twist and spin like a dolphin in the ocean. And don't we all enjoy looking up at the beautiful stars at night or gazing at tall, snowy mountains in the distance?

But **NONE** of this is **ANYTHING** as great as knowing God and being close to Him. That is the **BEST** thing anyone can ever enjoy. And that's why this spirit inside people makes us so very special, indeed!



**Clue Catchers:** Can you find Adam and Eve, the first people, in this picture?

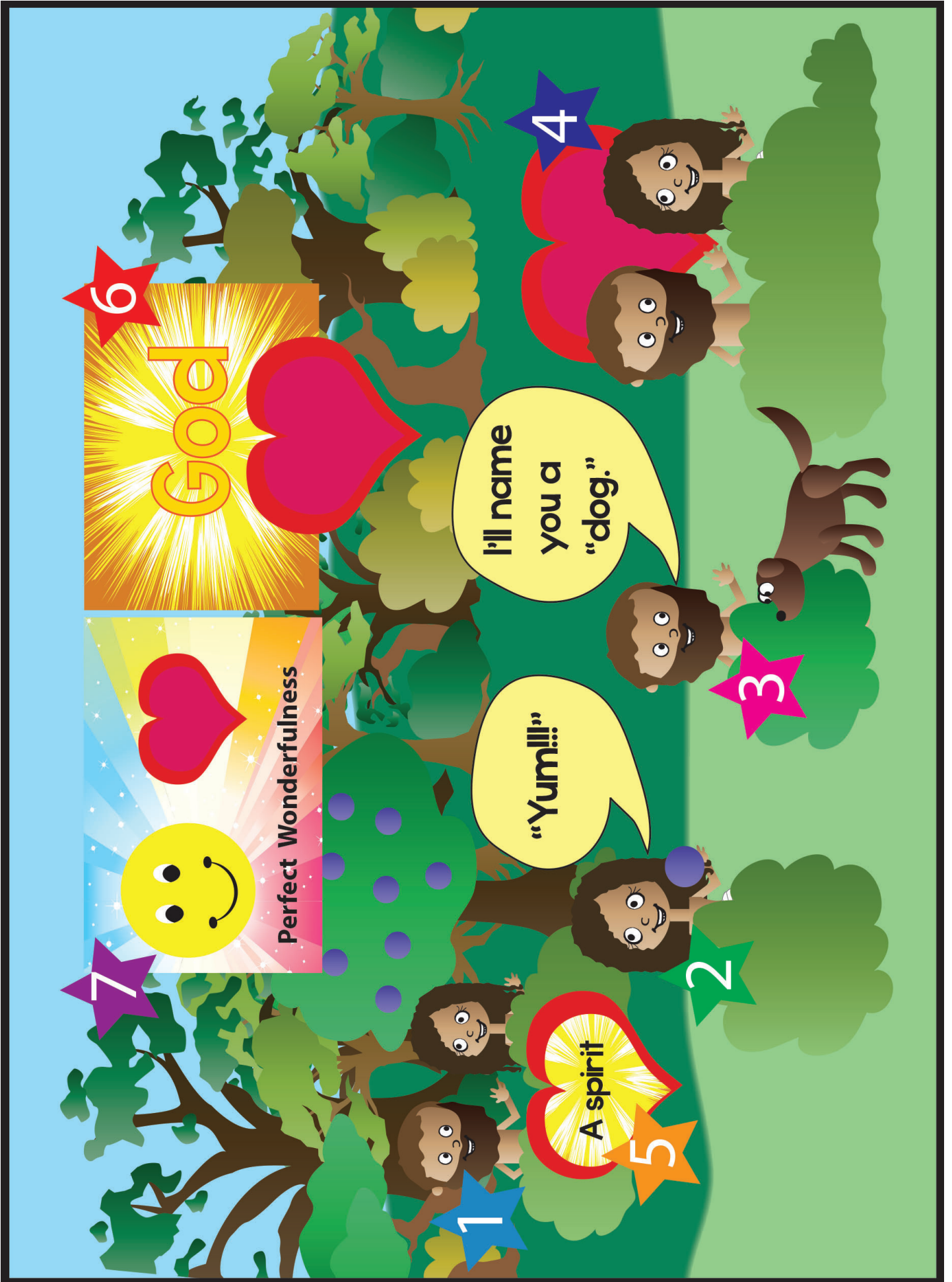

## Story Scene 2

God named the first man and woman, **1** Adam and Eve. He gave them a beautiful garden home with everything they needed— **2** perfect food to eat, **3** perfect jobs to do, and **4** perfect friendship to enjoy with each other.

But the best thing about life in the Garden, wasn't anything that Adam and Eve could put in their mouths, or do with their hands or even enjoy with each other. The best thing that Adam and Eve had in that Garden was something that they couldn't even see or touch. And it all had to do with that **5** spirit God gave them.

*Can you guess what that best thing was?*

The best thing about life in the Garden was **6** the very special closeness that they had with God.

What was that very special closeness like? I like to call it **7** "Perfect Wonderfulness.. "It was "Perfect", because there was no sin in Adam and Eve's hearts that blocked it. And it was "Wonderfulness," because it was far better than ANYTHING we can imagine.

*Doesn't the life Adam and Eve had with God sound amazing? Perfect Wonderfulness, lasting forever!*

"Perfect Wonderfulness" -- knowing, loving, trusting and obeying God completely. And God sharing His love and showing Himself to them in a way deeper and better than any of us has ever known. Yes, life with God in the Garden was "Perfect Wonderfulness." And what made it even MORE wonderful was that it could go on this way forever and ever.

*Doesn't the life Adam and Eve had with God sound amazing? Perfect Wonderfulness, lasting forever!*



**Clue Catchers: Can you point to the picture of Perfect Wonderfulness?**

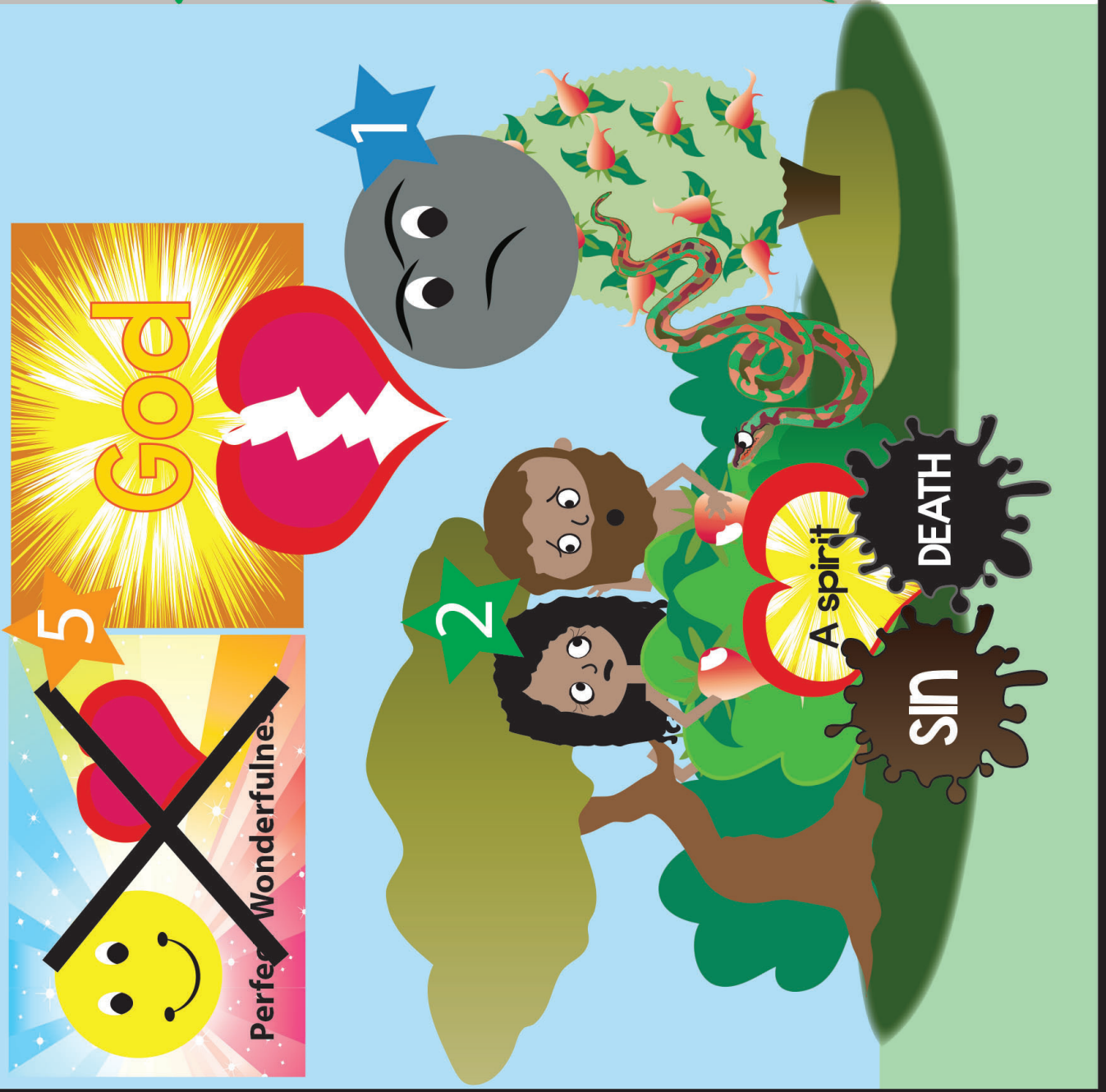



## Story Scene 3

But the “Perfect Wonderfulness” did NOT last forever.

1  Satan, God’s enemy, came into the Garden. He tempted Adam and Eve to doubt God and His goodness. His plan worked. 2  Right there, in the middle of that beautiful Garden of love, Adam and Eve stopped trusting God and chose to rebel against Him instead.

What would God do? Well, there was only one thing that He could do. You see, God is GOOD. 3  He is HOLY. He hates sin. It is BAD. So He did what He must do— He punished Adam and Eve for their disobeying.

4  Life in God’s perfect world was broken. Now there would be sin and sadness, sickness and death. Life in the Garden was broken, too. Adam and Eve lost their perfect food and perfect jobs and perfect friendship with each other. Worst of all, 5  they lost their Perfect Wonderfulness, their very special closeness with God that would have gone on forever and ever.

Oh, what a lot Adam and Eve lost on that sad, sad day!

But there was something that Adam and Eve did NOT lose on that day.

*Can you guess what it was?*

**They did NOT lose God’s love.**



**Clue Catchers: Can you find Adam and Eve disobeying God?**

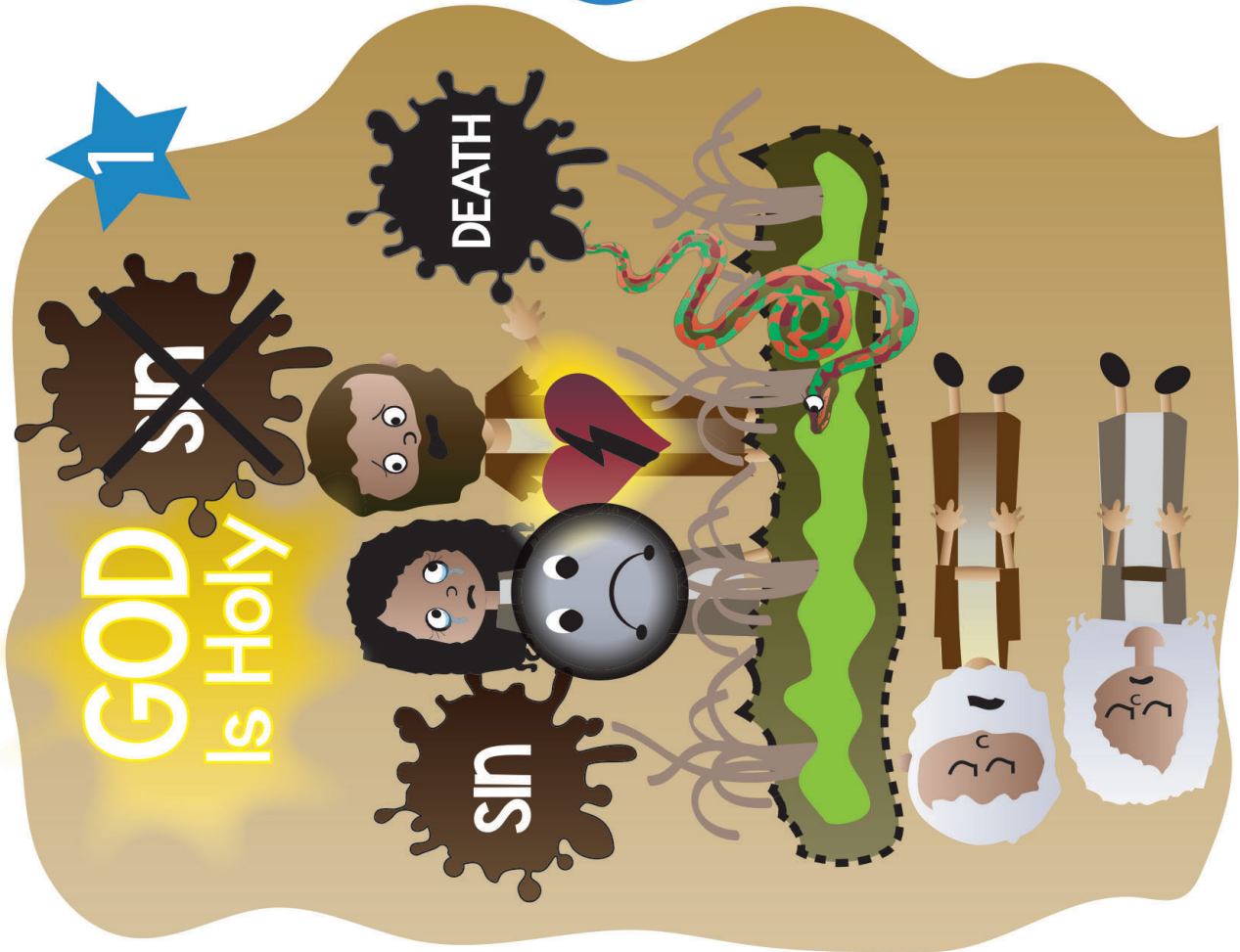

## Story Scene 4

God, in His great love and mercy was not finished with them or His world. He had always known what would happen. And He had always planned for it. 🌟 He would NOT lose His people to sin and death and Satan's plans. He was holy and He hated sin, but He would SAVE His people from their sins. 🌟 He, Himself, would do it.

So on that very day, God gave Adam and Eve a promise. He would send 🌟 a Savior to 🌟 crush the enemy. He would win back the Perfect Wonderfulness for them. He would win back the Forever Life with Him that He had created them to enjoy.

**Yes, He would win it all back, through the Savior He would send. We know His name, don't we?**

*Can you tell me the Savior's name?*

**The Savior would be Jesus, God's own Son.**



**Clue Catchers: Can you find the picture of sad things that can into the world when Adam and Eve disobeyed God?**

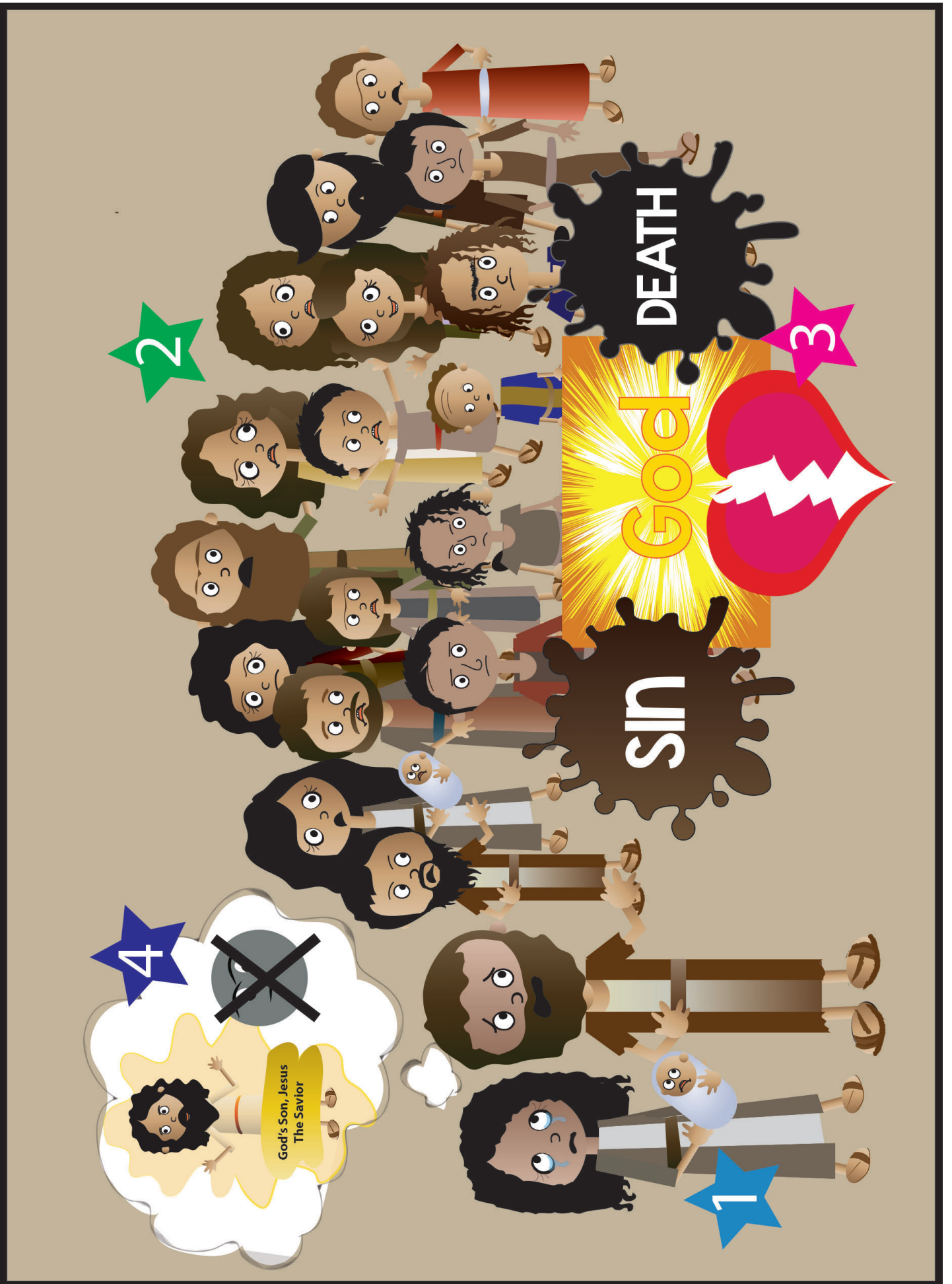

## Story Scene 5

1 Adam and Eve had a family. 2 Their children had children, too. They were just like Adam and Eve. They had two eyes, two ears, two legs, and two arms. One head with one nose and one mouth. They even had that special heart made to know and love God.

But sadly, 3 their hearts were broken with sin, just like Adam and Eve's. They ALL chose to disobey God and they ALL deserved His punishment. How sad!

But there was good news, too. Though they all disobeyed God and their hearts were broken with sin, 4 some remembered God's promise to crush their enemy. They trusted in God and looked forward in faith to the day when the Savior would come.

*Can you tell me the Savior's name?*

**The Savior would be Jesus, God's own Son.**



**Clue Catchers: Can you find the Savior God promised to send?**



## Story Scene 6

God's plan to send a Savior began to unfold. God chose **1** Abraham and his family to be the ones to prepare the world for the Savior.

He gave them **2** a special land to live in and **3** His laws to live by. He gave them His special promises, too.

God told them that all people would be blessed through someone who would be born into their family one day. **4** That someone would be the Savior.

*Can you tell me the Savior's name?*

**The Savior would be Jesus, God's own Son.**



**Clue Catchers: Can you find the picture of Abraham in the special land God gave him and his family?**

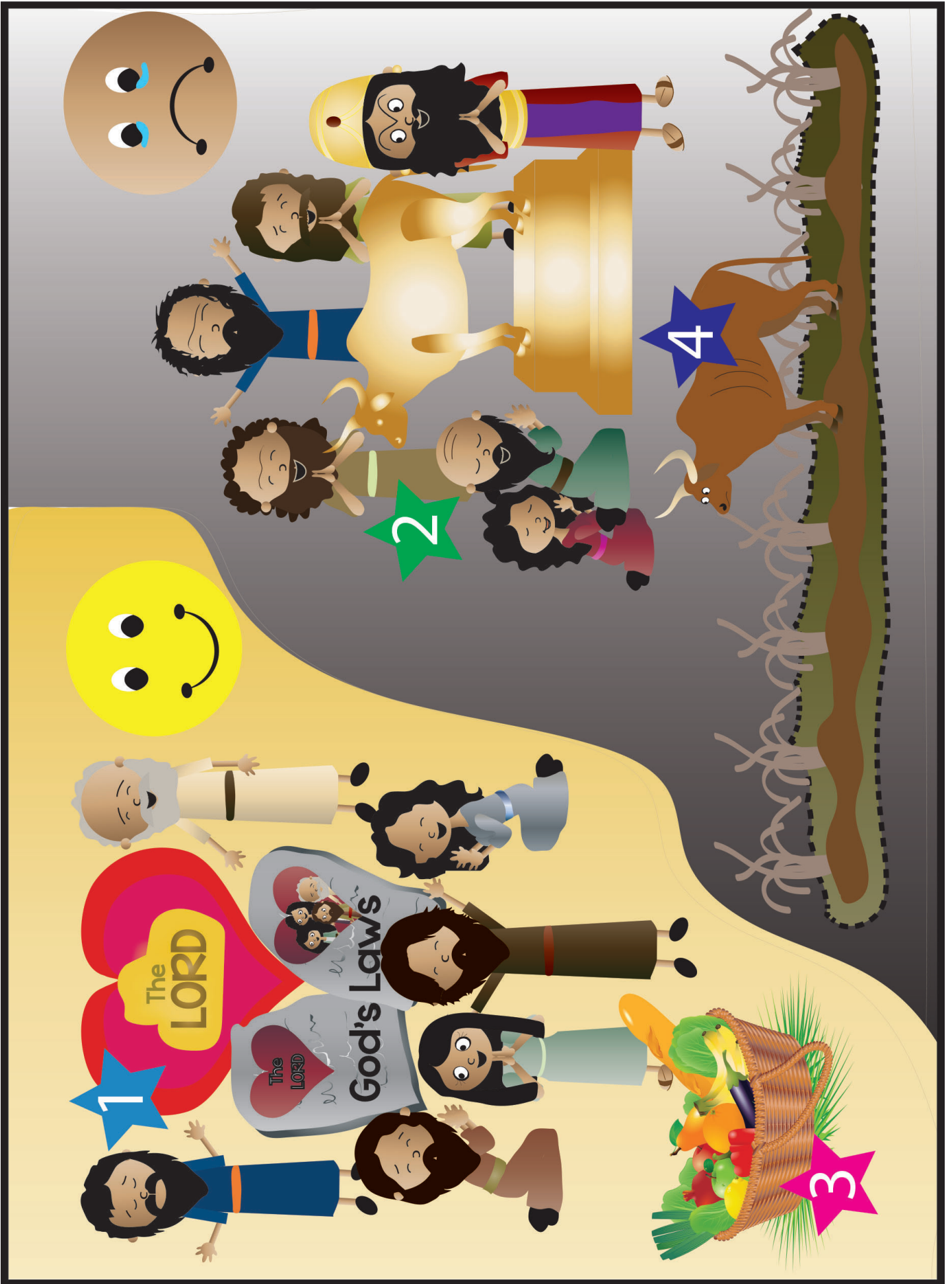



## Story Scene 7

Many years passed. Abraham's family grew into thousands and thousands and thousands of people. A whole nation!

Sometimes,  they obeyed God, but many times  they did not. They  enjoyed God's great blessings when they obeyed. They  felt His loving discipline when they did not.



**Clue Catchers: Can you find a picture of some of the good things God blessed Abraham's family with when they loved and obeyed Him?**



1

2

3

God's Son, Jesus  
The Savior

God's Word,  
The Bible

## Story Scene 8

When they kept refusing to obey, God's loving discipline became more painful. How God loved His people! So He gave them what they needed to turn back to Him. He  sent them far away from their home to work for their enemies.

They were so sad. They missed the good home and the good life He had given them. At last, their hearts changed. They were sorry they had disobeyed God. They wanted to turn back to Him.

God sent them good news: one day He would  bring them back home. And one day,  He would send a Savior.

*Can you tell me the Savior's name?*

**The Savior would be Jesus, God's own Son.**



**Clue Catchers: Can you find the people sent away from their home and having to work for their enemies?**

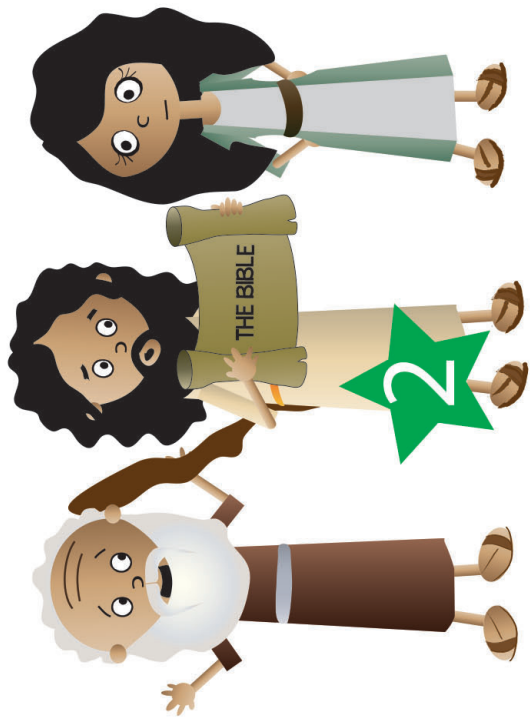
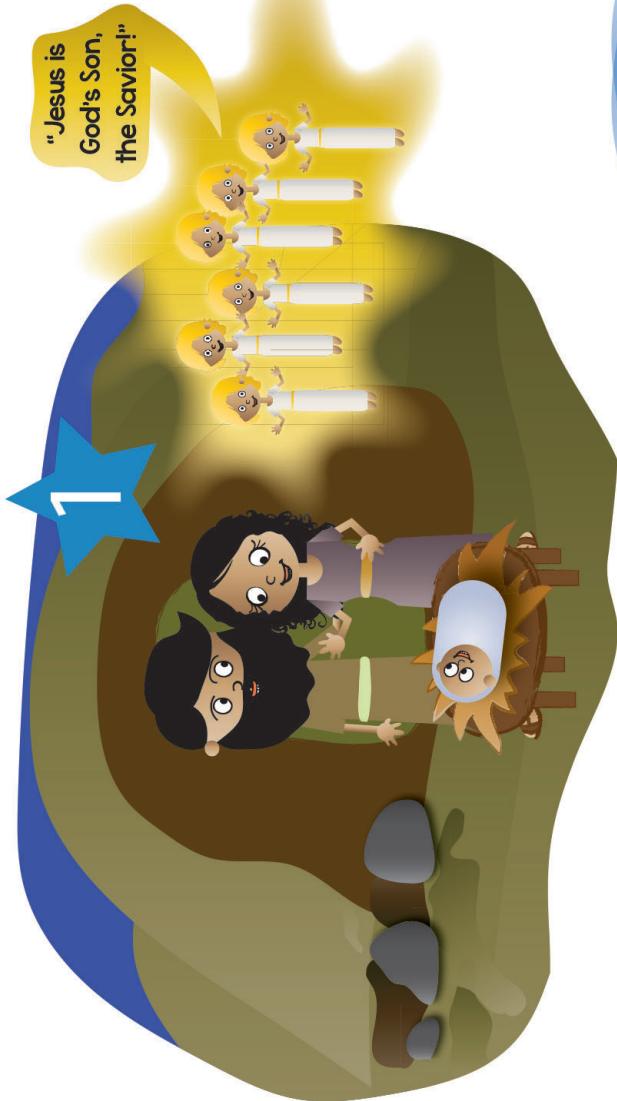

## Story Scene 9

God kept His promises. He brought Abraham's family back home. Then, at just the right time, He sent the Savior. **1** He was born in Bethlehem--Jesus, God's own Son.

Jesus grew up. He **2** taught about God and did many amazing things. **3** He lived a perfect life—the life that Adam and Eve and all of us were supposed to live, but never did. He showed that He was God's Son, the Savior.

But Jesus didn't just come to show us that He was the Savior. He came to BE the Savior. He would make the way for us to have special closeness with God again. He would pay for our sins so that through Him we could once more enjoy Perfect Wonderfulness with God forever.

But, oh, what a terrible way it must all happen! Sin couldn't be paid for **4** with money. Sin even couldn't be paid for by Jesus just LIVING a perfect life in our place.

109

No, sin could only be paid for with by Jesus living a perfect life, and then Him GIVING IT UP for us. He had to take our punishment. He had to die the death that we deserved! That was the only way! So that's what Jesus did. He **5** suffered and died on the cross as the perfect sacrifice for our sins. He was our substitute. He was our payment!

How Jesus hurt that day as He suffered and died for us! How much God loved us that He would pay for our sins, Himself, through His Son Jesus! As Jesus died on the cross, His last words were, "It is finished." But what was finished? What it just His life was finished? Or could it be something more? *What do you think Jesus finished?*

Later that day, some men took Jesus' body to a cave grave in a garden. That looked like the end. But was it?



**Clue Catchers: Can you find Jesus giving up His life on the cross to be our Savior?**

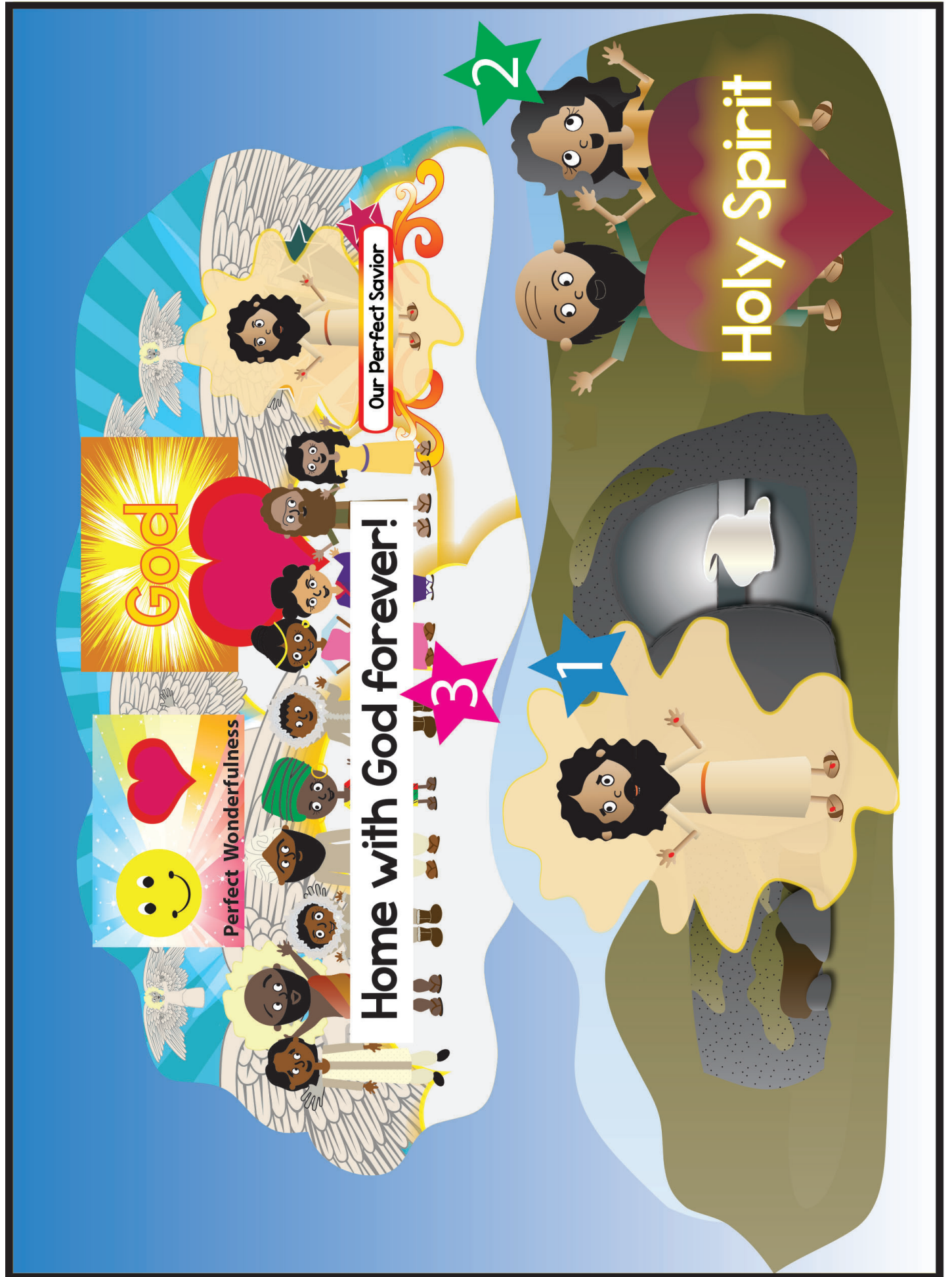

God

Perfect Wonderfulness

Home with God forever!

Our Perfect Savior

Holy Spirit

2

1

3

## Story Scene 10

**(No, it was not! What people had lost in their beautiful Garden long ago, Jesus was about to prove that He had won back in this garden.**

**On Day One and Two, Jesus' body stayed in that cave grave, but then on Day Three,  Jesus rose up from the dead in victory.**

**He was alive! Jesus had really beaten sin and death! That's what He had finished that day He suffered and died on the cross. All those sins paid for. The way back to Perfect Wonderfulness with God forever was made!**

**Now, all who turn away from their sins and trust in Jesus as their Savior can  enjoy a bit of special closeness with God in their hearts now by God's Holy Spirit.**

**And one day, when they die, they  will go to enjoy full, Perfect Wonderfulness with God forever. Perfect Wonderfulness. Perfect Forever. All of that is ours, all because the Savior came, and that Savior was God's Son, Jesus. Thank You, Jesus!**



**Clue Catchers: Can you find God's people living happily with God in heaven?**

**Cracking the Case:** (story wrap-up for Listening Assignments)

It's time to see how we did with our Listening Assignment.

**Detective Dan's Lesson 1 Listening Assignment:**

**1. Who was the Savior?** God's Son, Jesus.  
**2. When did the promise of a Savior start? When did it finish?** It started back in the beginning when Adam and Eve disobeyed God. It finished when Jesus died on the cross for the sins of God's people and rose from the dead in victory.

**For You and Me:**

The promise of the Savior wasn't just for Adam and Eve or all those people who lived long ago. It is for us, too. It is for all who turn away from their sins and trust in Jesus as their Savior. He came to give us special closeness with God. He came so we could know the Perfect Wonderfulness of life with God. Thank You, Jesus!

**Detective Dan's Lesson 2 Listening Assignment:****Our Bible Verse is Isaiah 53:5-6**

"But he was pierced for our transgressions, he was crushed for our iniquities; the punishment that brought us peace was upon him, and by his wounds we are healed. We all, like sheep, have gone astray, each of us has turned to his own way; and the LORD has laid on him the iniquity of us all!"

**I need to find out:**

**Transgressions and iniquities are other words for sin.**

**1. Whose transgressions and iniquities deserved God's punishment in our story?** All people.

**2. Who came to take God's punishment for them?**

Jesus, God's Son.

**For You and Me:**

The promise of the Savior wasn't just for Adam and Eve or all those people who lived long ago. It is for us, too. It is for all who turn away from their sins and trust in Jesus as their Savior. He came to give us special closeness with God. He came so we could know the Perfect Wonderfulness of life with God. He did this by paying for our sins, Himself! Thank You, Jesus!

**Detective Dan's Lesson 3 Listening Assignment:**

Our six clues were: a tree; a lamp; a garden; a cave grave; a bed; and, a man named Abraham.

**1. Which four belong in our story?**

The tree, the garden, the cave grave, and Abraham.

**2. Which one did the Savior use to prove He had won? What do we thank Him for beating?**

The cave grave. On the third day Jesus rose from the dead, showing that He had beat sin and death for all who turn away from their sins and trust in Him as their Savior.

**For You and Me:**

The promise of the Savior wasn't just for Adam and Eve or all those people who lived long ago. It is for us, too. It is for all who turn away from their sins and trust in Jesus as their Savior. He beat sin and death for us. He came to give us special closeness with God. He came so we could know the Perfect Wonderfulness of life with God. Thank You, Jesus!

**The Gospel** (story wrap-up if NOT using Listening Assignments)**Our Bible Truth is:****What Is the Gospel?**

**It's Salvation through Faith in Jesus Christ!**

**God sent Jesus to pay for the sins of God's people!**

How merciful is God! How great is His love for sinners, like you and me! Though we have all chosen to disobey Him, He always planned to provide us with a Savior! And that Savior would be His own, dear Son! He choose to suffer and die on the cross and give up His perfect life and the full payment for sin that we needed. How can He be our Savior? By turning away from our sins and trusting in Him as our Savior. Ask Him to help you! He loves to answer this prayer!

*Close in prayer.*



**Closing ACTS Prayer**

- A** God, we praise You for being the good Creator and King of the world.
- C** God, we confess rebelling against You and Your good ways. Too many times we choose to live life our own way instead of Yours. We need a Savior!
- T** Thank You for being our good Creator and King. Thank You for making everything in the world for Your good purposes. Thank You for being so merciful to us! Thank You for offering us salvation through Jesus, when we repent of our sins and trust Jesus as our Savior.
- S** God, work in our hearts, helping us to turn away from disobeying You. Help us to trust in Jesus as our Savior. Help us to joyfully obey You, as is best for us and brings You glory.

In Jesus' name we pray. Amen.



Questions to aid discussion of the key concepts and for use in games

Be familiar with these questions and answers. Look for opportunities to ask questions and discuss their answers, such as while the children work on their coloring pages, as part of their response games, or during play time. Remember: your goal isn't to ask all these questions or only talk to the children about these things. It is to be deliberate in having good conversations with them, however much or little you have.

<p><b>BIG QUESTION</b></p> <p><b>Meaning</b></p> <p><b>Discussion Questions</b></p>	<p>What is the Gospel? It's Salvation through Faith in Jesus Christ!</p> <p>Gospel means "good news." In the Bible, the gospel is the good news that God sent His Son Jesus to save sinners like you and me from the punishment we deserve for our sins. That salvation is ours when we turn from our sins and trust in Jesus as our own Savior.</p> <p><i>choose a few</i></p> <ol style="list-style-type: none"> <li>1. What is the gospel? <i>It's salvation through faith in Jesus!</i></li> <li>2. What does the word "gospel" mean? <i>It means "good news."</i></li> <li>3. Why is the gospel such good news? <i>It tells us how can forgive our sins and make us His people forever!</i></li> <li>4. Who do we need to have faith in? <i>Jesus.</i></li> <li>5. What did Jesus do so we can be saved? <i>He took the punishment for sin when He died on the cross.</i></li> <li>6. What does God want us to turn away from? <i>Our sins.</i></li> <li>7. What does it mean to turn away from our sins? <i>To say "no" to disobeying God and to want to obey Him, instead.</i></li> <li>8. Who can we ask to help us turn away from our sins and trust in Jesus? <i>God! He loves to help us when we ask Him.</i></li> </ol>
<p><b>BIBLE TRUTH</b></p> <p><b>Meaning</b></p>	<p>It's Salvation through Faith in Jesus Christ...God Sent Jesus to Pay for the Sins of God's People!</p> <p>What a mess we have made in God's good world! God is our good Maker and King, yet we have all chosen to disobey Him. Because God is good, He hates sin and He is right to punish our sins. We certainly deserve it! The punishment for sins is death--being separated from God and all His goodness forever. How sad!</p> <p>But God is not only good. He is also very merciful. He treats us better than we deserve. That's why God, Himself, made a way for us to be forgiven our sins and to become His people. God sent His own, dear Son, Jesus to live the perfect life of love and obedience that we should live, but never do. On the cross, Jesus offered His perfect life to God as the full payment for sin for all who turn away from their sins and trust in Him as their Savior. Jesus suffered and died in our place. Then on the third day, Jesus rose up from the dead, showing that He had really beaten sin and death! Jesus can be our Savior, too, when we turn away from our sins and trust in Him as our Savior.</p>
<p><b>Discussion Questions</b></p>	<p><i>choose a few</i></p> <ol style="list-style-type: none"> <li>1. Who is our good Maker and King? <i>God is.</i></li> <li>2. Who has chosen to disobey God? <i>We all have.</i></li> <li>3. What does God hate, because He is good? <i>He hates sin.</i></li> <li>4. What is God right to do to with our sin, because He hates it (and it is bad)? <i>He is right to punish our sin.</i></li> <li>5. What is God's punishment for sins? <i>It is death--being separated from God and all His goodness forever.</i></li> <li>6. Who did God send because He is not just good, but merciful, too? <i>The Savior, Jesus.</i></li> <li>7. What did Jesus do on the cross to save us? <i>He gave His perfect life as the full payment for sin.</i></li> <li>8. How can Jesus be our Savior? <i>When we turn away from our sins and trust in Him as our Savior.</i></li> </ol>

*Questions to aid discussion of the key concepts and for use in games*

<p><b>THE GOSPEL</b></p>	<p>What is God’s good news for you and me? <i>The gospel!</i> God made all people—including you and me! And He made us to know Him, love Him and obey Him. He’s our good king. But sadly, we have all disobeyed Him and we deserve His punishment. How sad! But God is so merciful that He sent a Savior. His Son, Jesus! Jesus suffered and died on the cross. He offered up His perfect life to God to completely pay for the sins of God’s people. That includes us, when we turn away from our sins and trust in Jesus as our Savior. He loves to helps us do this. Ask Him! How good is God to us!</p>
<p><b>BIBLE TRUTH BIBLE VERSE</b></p> <p><b>Meaning</b></p> <p><b>Discussion Questions</b></p> <p><i>choose a few</i></p>	<p>“But he was pierced for our transgressions, he was crushed for our iniquities; the punishment that brought us peace was upon him, and by his wounds we are healed. We all, like sheep, have gone astray, each of us has turned to his own way; and the LORD has laid on him the iniquity of us all.”--Isaiah 53:5-6</p> <p><b>Learn a Little:</b> “The punishment that brought us peace was upon him.”</p> <p>God is our good King and Creator and we should love and obey Him. But the sad news is that we all choose to disobey Him...and we all deserve His punishment. Yes, we deserve His punishment, but God has loved us so much that He sent His Son, Jesus to take the punishment that we deserve instead. Jesus lived a perfect life and chose to give it up to pay for our sins. On the cross He suffered and died. He was pierced with nails in His hands and feet. He was pierced in His side with a sword. He took all of the punishment that we deserve from God for our sins so that we could be forgiven. Jesus made the way for us to have peace with God by suffering in our place. Who did Jesus do this for? It is God’s free gift to all who put their trust in Jesus as their Savior and choose to live for Him. This gift can be for you, too! Ask God to help you. He loves to answer this prayer!</p> <p>1. Who has chosen to disobey God, our good King and Creator? <i>We all have.</i>                  2. Who did God send to take the punishment for our sins? <i>His Son, Jesus.</i>                  3. Where did Jesus take the punishment for our sins? <i>On the cross as He suffered and died.</i>                  4. Who did Jesus suffer and die for? <i>For all who turn away from their sins and trust in Him as their Savior. It is God’s free gift to all who do. It can be His gift to us, too!</i></p>
<p><b>BIBLE STORY</b></p> <p><b>Discussion Questions</b></p> <p><i>choose a few</i></p>	<p><b>The Case of the Savior, from Start to Finish</b></p> <p>1. Who enjoyed perfect wonderfulness with God in the beginning? <i>Adam and Eve did.</i>                  2. What did Adam and Eve do that changed everything? <i>They chose to disobey God.</i>                  3. What did Adam and Eve lose when they disobeyed God? <i>They lost the perfect world they lived in. And, they lost the wonderful life they had with God.</i>                  4. What did God promise to send Adam and Eve one day? <i>A Savior to save them from their sins.</i>                  5. What were the hearts of Adam and Eve’s children like? <i>They disobeyed God, too.</i>                  6. What did some of Adam and Eve’s children remember? <i>The promise of the Savior. They looked forward in faith to the day He would come.</i>                  7. What did God use Abraham’s family to do? <i>To be the family through whom the Savior would come. He would bless the whole world through this Savior.</i>                  8. Did Abraham’s family always obey God? <i>No, they didn’t. Many times they disobeyed Him.</i>                  9. Who did God send at just the right time? <i>The Savior, Jesus.</i>                  10. What did Jesus do with His perfect life to save us? <i>He gave it up to God as the full payment for sins as He suffered and died on the cross.</i>                  11. What did Jesus do on the third day after He was dead and buried? <i>He rose from the dead, showing He had beat sin and death for all who turn from their sins and trust in Him as their Savior.</i></p>

**CAN YOU GUESS BIBLE TRUTH 3:**

**What's the Gospel?**

**It's Salvation through Faith  
in Jesus Christ...**

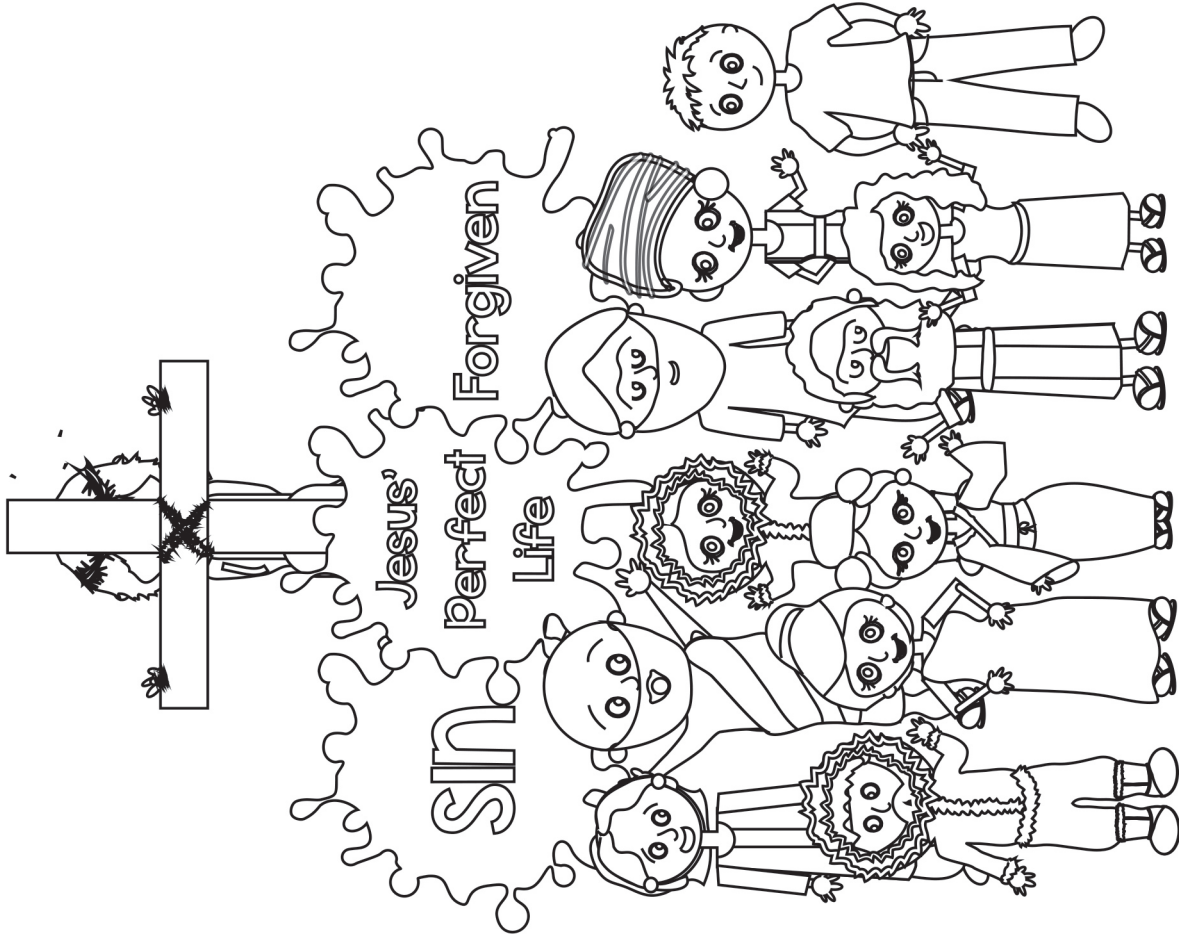

**God sent \_\_\_\_\_ to pay for the sins of God's people!**

**HINT: What's the name of God's Son?**

# Deep Down Detective Devotion: Unit 3, Bible Truth 3, Lesson 1



## Big Question 3 : What Is the Gospel?

**Answer:** It's Salvation through Faith in Jesus Christ... God sent Jesus to pay for the sins of God's people!

## Bible Truth 3 Meaning

What a mess we have made in God's good world! God is our good Maker and King, yet we have all chosen to disobey Him. Because God is good, He hates sin and He is right to punish our sins. We certainly deserve it! The punishment for sins is death--being separated from God and all His goodness forever. How sad!

But God is not only good. He is also very merciful. He treats us better than we deserve. That's why God, Himself, made a way for us to be forgiven our sins and to become His people. God sent His own, dear Son, Jesus to live the perfect life of love and obedience that we should live, but never do. On the cross, Jesus offered His perfect life to God as the full payment for sin for all who turn away from their sins and trust in Him as their Savior. Jesus suffered and died in our place. Then on the third day, Jesus rose up from the dead, showing that He had really beaten sin and death! Jesus can be our Savior, too, when we turn away from our sins and trust in Him as our Savior.

## How do I know this is true? The Bible tells me so!

"But he was pierced for our transgressions, he was crushed for our iniquities; the punishment that brought us peace was upon him, and by his wounds we are healed. We all, like sheep, have gone astray, each of us has turned to his own way; and the LORD has laid on him the iniquity of us all." --- Isaiah 53:5-6

## Some Questions for You

1. Who is our good Maker and King? *God is.*
2. Who has chosen to disobey God? *We all have.*
3. What does God hate, because He is good? *He hates sin.*
4. What is God right to do to with our sin, because He hates it (and it is bad)? *He is right to punish our sin.*
5. What is God's punishment for sins? *It is death--being separated from God and all His goodness forever.*
6. Who did God send because He is not just good, but merciful, too? *The Savior, Jesus.*
7. What did Jesus do on the cross to save us? *He gave His perfect life as the full payment for sin.*
8. How can Jesus be our Savior? *When we turn away from our sins and trust in Him as our Savior.*

## Let's Pray!

- A** God, we praise You for being the good Creator and King of the world.
- C** God, we confess rebelling against You and Your good ways. Too many times we choose to live life our own way instead of Yours. We need a Savior!
- T** Thank You for being our good Creator and King. Thank You for making everything in the world for Your good purposes. Thank You for being so merciful to us! Thank You for offering us salvation through Jesus, when we repent of our sins and trust Jesus as our Savior.
- S** God, work in our hearts, helping us to turn away from disobeying You. Help us to trust in Jesus as our Savior. Help us to joyfully obey You, as is best for us and brings You glory. In Jesus' name we pray. Amen.

## Let's Sing about What We're Learning!

**Big Q & A 3 Song** from *Deep Down Detectives NIV Songs 3, track 12*  
(sung to the tune of "Oh, My Darlin' Clementine")

What's the gospel?  
What's the gospel?  
Can you tell me what it is?  
It's salvation through faith in Jesus,  
That's what the gospel is. (repeat)

**Big Question 3 Action Rhyme Song** from *Deep Down Detectives NIV Songs 3, track 13*

### Refrain:

What is the gospel?  
G-O-S-P-E-L?  
What is the gospel?  
Can anybody tell me?  
What is the gospel?  
Yes, I know what it is!  
Salvation through faith in Christ,  
That's what the gospel is.

"G" is for God,  
our good King and Creator,  
O, we should obey Him,  
but instead we're disobeyers,  
So S, we need a Savior  
to save us from our sins,  
That Savior is Jesus,  
who "P" took the punishment.

Yes, Jesus died upon the cross,  
the perfect sacrifice,  
Then on Day Three, He rose again  
To prove He'd won the fight,

And now "E" everyone who repents  
and believes in Him,  
He gives "E-L" eternal life: forever life with Him. *Refrain*

Go to the *Deep Down Detectives Parent Resources for Unit 3* to get the Bible story and many more resources and songs for this unit at [praisefactory.org](http://praisefactory.org)

**“But he was pierced for our transgressions,  
he was crushed for our iniquities;  
the punishment that brought us peace was upon him,  
and by his wounds we are healed.**

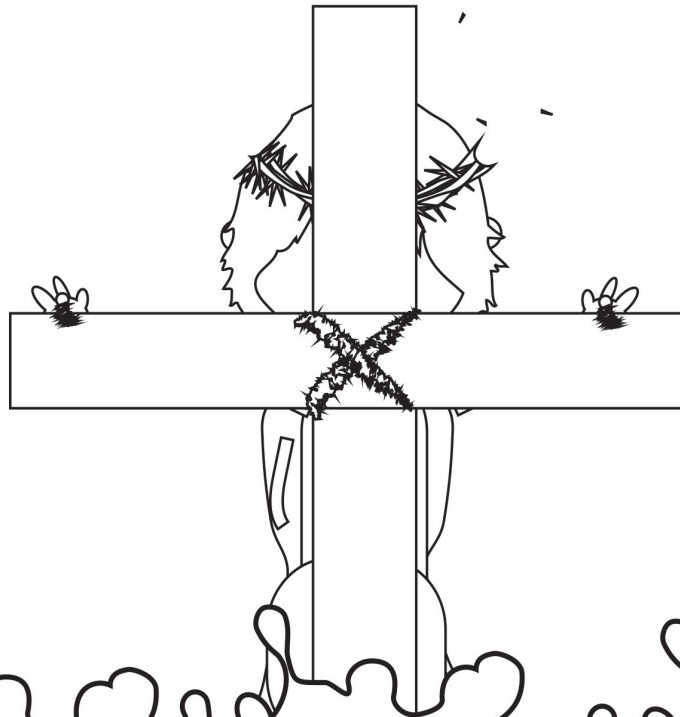

**SIN** Jesus' **Perfect** **Forgiven**  
**Life**

**We all, like sheep, have gone astray,  
each of us has turned to his own way;  
and the LORD has laid on him the iniquity of us all.”**

**Isaiah 53:5-6**

## Deep Down Detective Devotion: Unit 3, Bible Truth 3, Lesson 2



**Big Question 3 :** What Is the Gospel?

**Answer:** It's Salvation through Faith in Jesus Christ... God sent Jesus to pay for the sins of God's people!

**How do I know this is true? The Bible tells me so!**

"But he was pierced for our transgressions, he was crushed for our iniquities; the punishment that brought us peace was upon him, and by his wounds we are healed. We all, like sheep, have gone astray, each of us has turned to his own way; and the LORD has laid on him the iniquity of us all." --- Isaiah 53:5-6

**Learn a Little:** "The punishment that brought us peace was upon him."

**Meaning**

God is our good King and Creator and we should love and obey Him. But the sad news is that we all choose to disobey Him...and we all deserve His punishment.

Yes, we deserve His punishment, but God has loved us so much that He sent His Son, Jesus to take the punishment that we deserve instead. Jesus lived a perfect life and chose to give it up to pay for our sins. On the cross He suffered and died. He was pierced with nails in His hands and feet. He was pierced in His side with a sword. He took all of the punishment that we deserve from God for our sins so that we could be forgiven. Jesus made the way for us to have peace with God by suffering in our place.

Who did Jesus do this for? It is God's free gift to all who put their trust in Jesus as their Savior and choose to live for Him. This gift can be for you, too! Ask God to help you. He loves to answer this prayer!

**Some Questions for You**

1. Who has chosen to disobey God, our good King and Creator? *We all have.*
2. Who did God send to take the punishment for our sins? *His Son, Jesus.*
3. Where did Jesus take the punishment for our sins? *On the cross as He suffered and died.*
4. Who did Jesus suffer and die for? *For all who turn away from their sins and trust in Him as their Savior. It is God's free gift to all who do. It can be His gift to us, too!*

**Let's Pray!**

- A** God, we praise You for being the good Creator and King of the world.
- C** God, we confess rebelling against You and Your good ways. Too many times we choose to live life our own way instead of Yours. We need a Savior!
- T** Thank You for being our good Creator and King. Thank You for making everything in the world for Your good purposes. Thank You for being so merciful to us! Thank You for offering us salvation through Jesus, when we repent of our sins and trust Jesus as our Savior.
- S** God, work in our hearts, helping us to turn away from disobeying You. Help us to trust in Jesus as our Savior. Help us to joyfully obey You, as is best for us and brings You glory. In Jesus' name we pray. Amen.

**Let's Sing Our Bible Verse!**

**He Was Pierced** *from Deep Down Detectives NIV Songs 3, track 21*

He was pierced, He was pierced,  
He was pierced for our transgressions,  
He was crushed, He was crushed,  
He was crushed for our iniquities.

The punishment for our peace was upon Him, upon Him,  
And by His wounds, we are healed, we are healed.

He was pierced, He was pierced,  
He was pierced for our transgressions,  
He was crushed, He was crushed,  
He was crushed for our iniquities.  
Isaiah Fifty-three, verse five.

*Go to the Deep Down Detectives Parent Resources for Unit 3 to get the Bible story and many more resources and songs for this unit at [praisefactory.org](http://praisefactory.org)*



Which four of these clues belong in our story? Which two do not? Put an X in the boxes of the four that belong.

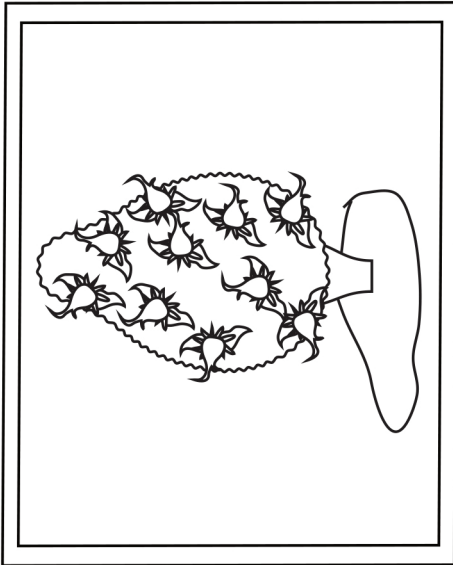

A Tree

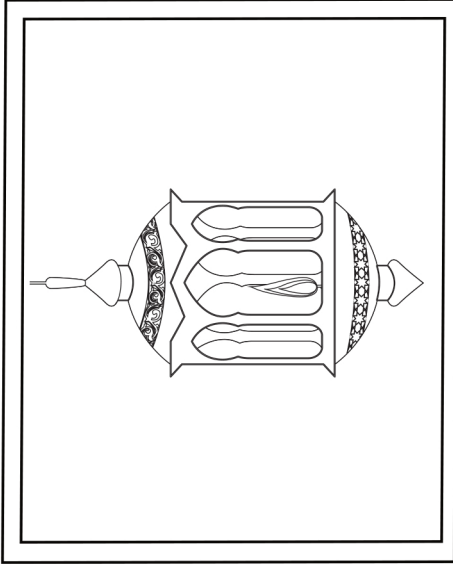

A Lamp

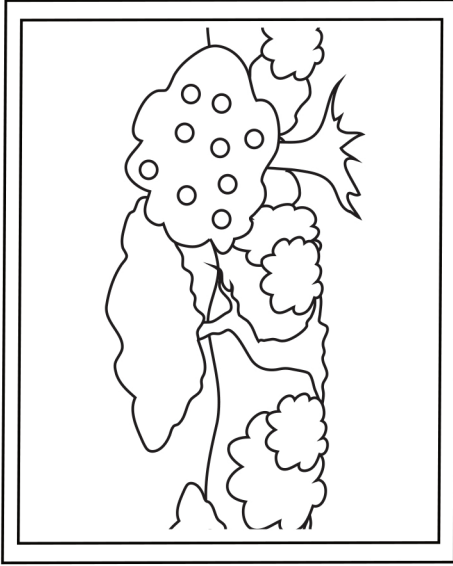

A Garden

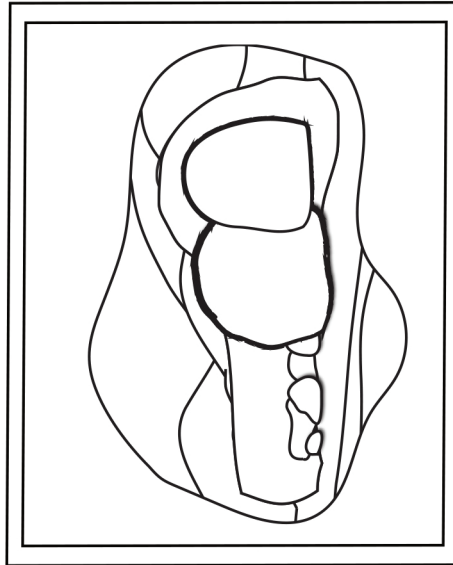

A Cave Grave

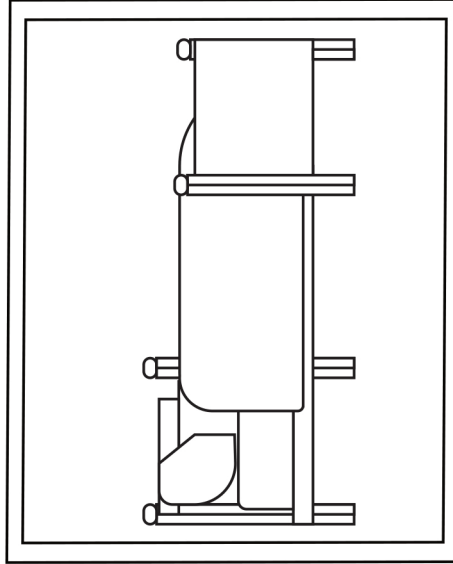

A Bed

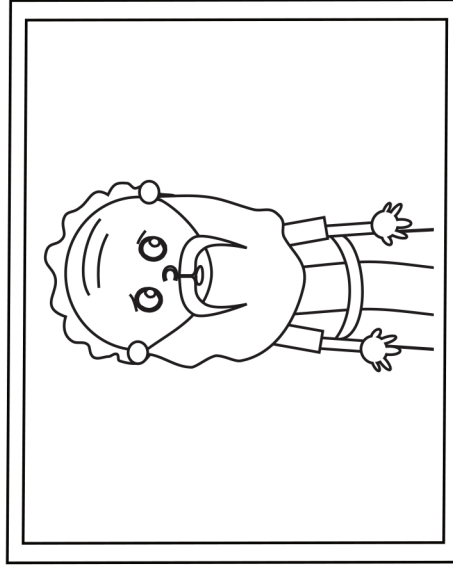

A Man Named Abraham

Answer: The tree; the garden; the cave grave; and the man named Abraham belong. The lamp and the bed do not.

# Deep Down Detective Devotion: Unit 3, Bible Truth 3, Lesson 3



## Big Question 3 : What Is the Gospel?

**Answer:** It's Salvation through Faith in Jesus Christ... God sent Jesus to pay for the sins of God's people!

## Bible Truth 3 Meaning

What a mess we have made in God's good world! God is our good Maker and King, yet we have all chosen to disobey Him. Because God is good, He hates sin and He is right to punish our sins. We certainly deserve it! The punishment for sins is death--being separated from God and all His goodness forever. How sad! But God is not only good. He is also very merciful. He treats us better than we deserve. That's why God, Himself, made a way for us to be forgiven our sins and to become His people. God sent His own, dear Son, Jesus to live the perfect life of love and obedience that we should live, but never do. On the cross, Jesus offered His perfect life to God as the full payment for sin for all who turn away from their sins and trust in Him as their Savior. Jesus suffered and died in our place. Then on the third day, Jesus rose up from the dead, showing that He had really beaten sin and death! Jesus can be our Savior, too, when we turn away from our sins and trust in Him as our Savior.

## How do I know this is true? The Bible tells me so!

"But he was pierced for our transgressions, he was crushed for our iniquities; the punishment that brought us peace was upon him, and by his wounds we are healed. We all, like sheep, have gone astray, each of us has turned to his own way; and the LORD has laid on him the iniquity of us all." --- Isaiah 53:5-6

## Some Questions for You

Our six case clues were: a tree; a lamp; a garden; a cave grave; a bed; and, a man named Abraham.

1. Which four belong in our story?

*The tree, the garden, the cave grave, and Abraham.*

2. Which one did the Savior use to prove He had won? What do we thank Him for beating?

*The cave grave. On the third day Jesus rose from the dead, showing that He had beat sin and death for all who turn away from their sins and trust in Him as their Savior.*

3. What did Adam and Eve lose when they disobeyed God? *They lost the perfect world they lived in. And, they lost the wonderful life they had with God.*

4. What did God promise to send Adam and Eve one day? *A Savior to save them from their sins.*

5. What did God use Abraham's family to do? *To be the family through whom the Savior would come. He would bless the whole world through this Savior.*

6. Who did God send at just the right time? *The Savior, Jesus.*

7. What did Jesus do with His perfect life to save us? *He gave it up to God as the full payment for sins as He suffered and died on the cross.*

8. How can Jesus be our Savior? *When we turn away from our sins and trust in Jesus as our Savior.*

## Let's Pray!

**A** God, we praise You for being the good Creator and King of the world.

**C** God, we confess rebelling against You and Your good ways. Too many times we choose to live life our own way instead of Yours. We need a Savior!

**T** Thank You for being our good Creator and King. Thank You for making everything in the world for Your good purposes. Thank You for being so merciful to us! Thank You for offering us salvation through Jesus, when we repent of our sins and trust Jesus as our Savior.

**S** God, work in our hearts, helping us to turn away from disobeying You. Help us to trust in Jesus as our Savior. Help us to joyfully obey You, as is best for us and brings You glory. In Jesus' name we pray. Amen.

## Let's Praise God Right Now!

### Big Q & A 3 Hymn: And Can It Be

*from Deep Down Detectives NIV Songs 3, track 17*

#### Refrain

Amazing love, how can it be?

That thou, my God, should die for me?

Amazing love, how can it be?

That thou, my God, should die for me?

Words: Charles Wesley Music: Thomas Campbell

### Big Question 3 Praise Song: I Have Decided to Follow Jesus

*from Deep Down Detectives NIV Songs 3, track 18*

I have decided to follow Jesus,

I have decided to follow Jesus,

I have decided to follow Jesus,

No turning back, no turning back.

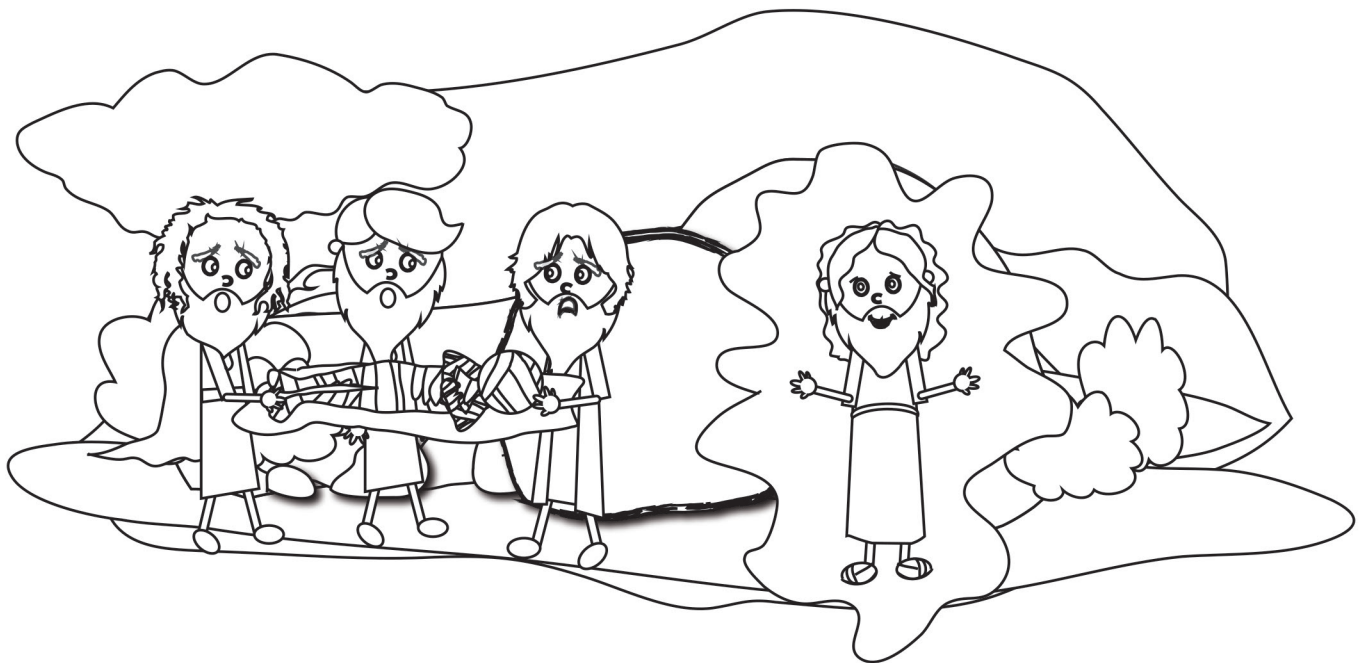
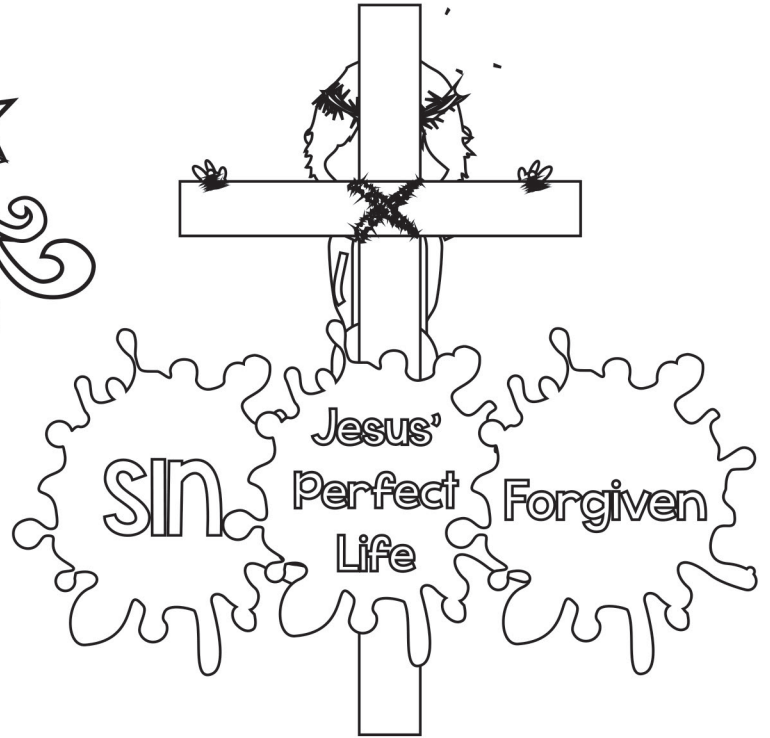

**What Is the Gospel? It's Salvation through Faith in Jesus Christ...God Sent Jesus to Pay for the Sins of God's People!**

How merciful is God! How great is His love for sinners, like you and me! Though we have all chosen to disobey Him, He always planned to provide us with a Savior! And that Savior would be His own, dear Son! He choose to suffer and die on the cross and give up His perfect life and the full payment for sin that we needed. How can He be our Savior? By turning away from our sins and trusting in Him as our Savior. Ask Him to help you! He loves to answer this prayer!

# The Case of the Savior, from First to Last Jigsaw Puzzle Page

Genesis, The Gospels

Make copies of picture and cut out into an appropriate number of pieces for your children.  
Or, you can print out color versions of this puzzle by downloading it from [praisefactory.org](http://praisefactory.org).

What Is the Gospel? It's Salvation through Faith in Jesus Christ...God Sent Jesus to Pay for the Sins of God's People!

How merciful is God! How great is His love for sinners, like you and me! Though we have all chosen to disobey Him, He always planned to provide us with a Savior! And that Savior would be His own, dear Son! He choose to suffer and die on the cross and give up His perfect life and the full payment for sin that we needed. How can He be our Savior? By turning away from our sins and trusting in Him as our Savior. Ask Him to help you! He loves to answer this prayer!



# **DEEP DOWN DETECTIVES**

**Fundamentals:**

**Unit 3, Bible Truth 4**



**What Is the Gospel?**

**It's Salvation through Faith**

**in Jesus Christ...**

**God Saves All Who Repent of Their  
Sins and Trust in Jesus as Savior!**



---

## Unit 3: The Good News of God, the Gospel

---

### UNIT OVERVIEW

Gospel means “good news.” In the Bible, the gospel is the good news that God sent His Son Jesus to save sinners like you and me from the punishment we deserve for our sins. That salvation is ours when we turn from our sins and trust in Jesus as our own Savior. Now that is good news indeed!

In this unit we will learn four ways the gospel is such good news.

### UNIT BIBLE VERSE: John 3:16

“For God so loved the world that he gave his one and only Son, that whoever believes in him shall not perish but have eternal life.”

### BIG QUESTION UNDER INVESTIGATION: What Is the Gospel?

**ANSWER:** It’s Salvation through Faith in Jesus Christ!

#### **OPTIONAL Big Question 3 INTRODUCTION LESSON (Use Hide ‘n’ Seek Kids Unit 3 Material)**

Story: The Case of the Stranger’s Very Good News *Acts 8:1-8*

Bible Verse: John 3:16

#### **BIBLE TRUTH 1: God Made Us and We Should Obey Him** (3 Lessons Available)

Story: The Case of the God Who Was Different *Acts 17:16-33*

Bible Verse: Psalm 100:1-4

#### **BIBLE TRUTH 2: We Have All Disobeyed God and Deserve His Punishment** (3 Lessons Available)

Story: The Case of the Squabbling Brothers and Sisters *Romans*

Bible Verse: Ecclesiastes 7:20,29

#### **BIBLE TRUTH 3: God Sent Jesus to Pay for the Sins of God’s People** (3 Lessons Available)

Story: The Case of the Savior, from Start to Finish *Genesis, The Gospels*

Bible Verse: Psalm 119:18,72-73

#### **➔ BIBLE TRUTH 4: God Saves All Who Repent of Their Sins and Trust in Jesus as Their Savior**

(3 Lessons Available)

Story: The Case of Cruddy Crete *Titus*

Bible Verse: Mark 1:15

---

## Deep Down Detectives NIV Songs 3 Track Numbers

---

This is a listing of all songs mentioned in the unit curriculum. You may or may not choose to use all of the songs. They are listed in easy-reference order--NOT in the order used in the curriculum.

You may choose to simply burn a CD/load them onto an mp3 device in this order. Or, you may want to do what we do: choose the songs we want to use and create a play list of them in that order. Then, we burn a CD/upload the play list onto an mp3 device. A teacher only has to click forward to the next song, instead of hunting for the right track. The track number have been included as part of the title of each song, so teachers will still have a reference to the track number listed in the curriculum (same as those listed below), even if you change the order on your customized play list.

### SONGS USED EVERY UNIT OF THE CURRICULUM

- 1 The Classroom Song v.1
- 2 The Classroom Song v.2
- 3 The Classroom Song v.3
- 4 The Classroom Song v.4
- 5 Deep Down Detectives Theme Song
- 6 The Classroom Rules Song
- 7 Let's Pray Song
- 8 The Big Question Box Song
- 9 The Bible Chant Song
- 10 ACTS Prayer Song (Short Version)
- 11 ACTS Prayer Song (Full Version)

#### Why the Extra Songs?

Deep Down Detectives is a curriculum used by a wide age-span of kids. Sometimes one of the other songs is a better fit for your kids. Or, you may simply want to teach them more songs on the same Bible Truth. Use as many or as few as you want.

### UNIT 3: GOD'S GOOD NEWS, THE GOSPEL

- 12 Big Q & A 3 Song
- 13 Big Question 3 Song: What's the Gospel?
- 14 Big Question 3 Bible Verse Song: For God So Loved the World John 3:16
- 15 *Extra Big Question 3 Bible Verse Song: For God So Loved the World John 3:16 (version 2)*
- 16 *Extra Big Question 3 Bible Verse Song: For God So Loved the World John 3:16 (version 3)*
- 17 Big Question 3 Hymn: And Can It Be, v.1 Refrain
- 18 Big Question 3 Praise Song: I Have Decided to Follow Jesus

#### What Is the Gospel?

#### Salvation through Faith in Christ...

#### Bible Truth 1: God Made Us and We Should Obey Him

- 19 Bible Verse: Shout for Joy Psalm 100:1,2

#### Bible Truth 2: We Have All Disobeyed God and Deserve His Punishment

- 20 Bible Verse: There Is Not a Righteous Man Ecclesiastes 7:20,29

#### Bible Truth 3: God Sent Jesus to Pay for the Sins of God's People!

- 21 Bible Verse: He Was Pierced Isaiah 53:5

#### Bible Truth 4: God Saves All Who Repent of Their Sins and Trust in Jesus

- 22 Bible Verse: The Time Has Come Mark 1:15
- 23 *Extra Bible Verse: Help Us, O God, Our Savior Psalm 79:9*



**Unit 3: The Good News of God, the Gospel**

**Unit Big Question (and Answer):** What Is the Gospel? It's Salvation through Faith in Jesus Christ!

**Unit Bible Verse:** "For God so loved the world that he gave his one and only Son, that whoever believes in him shall not perish but have eternal life." John 3:16

**Bible Truth 4 Concept: Salvation through Faith in Jesus Christ...God Saves All Who Repent of Their Sins and Trust in Jesus as Their Savior!**

God is our good Creator and King. He made us to know Him, love Him and obey His good laws. But sadly, we all have chosen to disobey God and His good laws. We deserve His punishment for our sins. We have all turned away from Him.

But God has made a way for us to be forgiven our sins and to become His people. In His great love and mercy, God sent His Son, Jesus to be our Savior. Jesus lived a perfect life. He never disobeyed God. He offered up His life as the full payment for sin when He suffered and died on the cross. On the third day, He rose from the dead. Jesus had done it! He had beaten sin and death for God's people!

How can we become one of God's people? Who can receive God's gift of forgiveness? All who repent of their sins and trust in Jesus as their Savior. Repent means to stop living a life full of disobeying God and to start living to please God, instead. God can help us repent and believe. Ask Him!

How wonderful it is to be one of God's people! To have special closeness with God by His Holy Spirit living in your heart now. And one day, to go live with God forever. That will be best of all!

**Bible Truth 4 Bible Verse: Mark 1:15**

"The time has come," he said. "The kingdom of God is near. Repent and believe the good news!"

**Learn a Little:** "Repent and believe the good news!"

**Meaning**

For years and years, God had promised to send a Savior to save us from our sins. For years and years, people waited and watched...and they watched and waited. At last, Jesus came! He taught the people about God and did amazing things. He showed them that He was God's Son, the Savior God had promised.

But what did people have to do, if they were to be forgiven by God for their sins? Jesus told them: "Repent and believe in the gospel--the good news that Jesus was God's Son, the Savior, sent to save them. We can be forgiven, too, when we repent--that is, turn away from disobeying God and living life our own way-- and believe that Jesus is God's Son, the Savior. God loves to help us do this. Ask Him!

**Bible Truth 4 ACTS Prayer**

- A** God, we praise You for being so full of love and mercy! You call us to repent and believe in Jesus that we might be saved.
- C** We confess that we often disobey You and Your good ways. We choose to live life our own way, not Yours. We need a Savior!
- T** Thank God for offering us salvation through Jesus, when we repent of our sins and trust in Jesus as our Savior.
- S** God, work in our hearts. Help us to trust in Jesus as our Savior. Help us to joyfully obey You. You know what is best for us and what brings You glory. In Jesus' name we pray. Amen.

**Bible Truth 4 Story**

**The Case of the Changes in Cruddy Crete**

*Titus*

**Songs Used in Bible Truth 4**

Big Question 3 Bible Verse Song: For God So Loved the World John 3:16

*Extra Big Question 3 Bible Verse Song: For God So Loved the World John 3:16 (version 2)*

*Extra Big Question 3 Bible Verse Song: For God So Loved the World John 3:16 (version 3)*

Big Question 3 Hymn: And Can It Be, v.1 Refrain

Big Question 3 Praise Song: I Have Decided to Follow Jesus

Bible Truth 4 Bible Verse Song: The Time Has Come Mark 1:15

*Extra Bible Truth 4 Bible Verse Song: Help Us, O God, Our Savior Psalm 79:9*

**The Case of the Changes in Cruddy Crete***Titus***Story-telling Tips**

Ahead of time:

1. Read the Bible verses and story. Pray!
2. Practice telling story with expression. Look for words that might be new to your children. Plan to explain the meaning of them to the children. The numbers in the story correspond to elements of the picture. Practice pointing to the pictures as you read the story. Shorten the story, if necessary, for your child/group of children.
3. If desired, choose a listening assignment for the children (listed below). Listening with a purpose helps the children keep focused and glean more from the story. The three, different assignments allow you to re-tell the story three times with fresh purpose. Answers to the listening assignments are found at the end of the story.

During your presentation:

1. If you are telling the story to a group of children, maintain as much eye contact as possible as you tell the story. Tell the story with enthusiasm and expression. Take time to show each story scene to the children as you tell it. Use the cue numbers in the story to highlight corresponding parts of the picture as you tell the story.
2. The Clue Catcher question at the bottom of each scene helps the children keep engaged with the story.
3. Include the children in your story with a few questions about what they think will happen or words/concepts that might be new to them.
4. Watch the kids for signs that their attention span has been reached. Shorten, if necessary.
5. At end of the story, repeat the listening assignment question and ask for answers. Close in prayer.

**INTRODUCTION/ LISTENING ASSIGNMENTS (Optional)****“Our story is called: The Case of the Changes in Cruddy Crete. Here is your listening assignment... “***(optional)***Detective Dan’s Lesson #1 Listening Assignment:**

I need to find out:

Cruddy is a word that means something is no good.

- 1. What was Crete and what was so cruddy about it?**
- 2. Who changed in Crete? How did they change?**

**Detective Dan’s Lesson #2 Listening Assignment:****Our Bible Verse is Mark 1:15:***“The time has come,” he said. “The kingdom of God is near. Repent and believe the good news!”*

I need to find out:

- 1. Who went to Crete to tell the people to repent and believe?**
- 2. What was the gospel that he wanted them to repent and believe in?**

**Detective Dan’s Lesson #3 Listening Assignment:**

I found six clues, but only 4 of them are in the story.

They are: A liar; a palm tree; a pizza; a pair of shoes; a man named Titus; and, a lazy, over-eater.

*Hold each of them up for the children to see as you identify them.*

I need to figure out:

- 1. Which four belong in our story?**
- 2. Who repented of their sins and asked God for forgiveness? Who helped them do this?**

**Read the assignment questions, THEN SAY,***“Ok, Deep Down Detectives! Put on your best listening ears and see if you can hear the answers to Detective Dan’s questions. When I finish telling the story, we will see if we can answer all the questions.”**Read the Bible Truth story, answer questions, present the gospel and lead in prayer.**Answers to questions; the gospel; and, ACTS prayer are included with the story text.*



## Story Scene 1



**This story is an island story. Do you know what an island is?**

*What can you tell me about an island?*

**It's a little piece of land stuck out in the middle of a big piece of water, such as a sea or an ocean. The island in this story was very famous for something. Let's think what it might be.**

**Some islands are famous for their  tall, volcano mountains that spray out smoke and hot lava. THIS island had tall, volcano mountains with smoke and lava...but that's not what it was famous for.**

**Some islands are famous for their  beautiful, sandy beaches with palm trees blowing in the breeze and  colorful fish swimming in the clear, blue water. THIS island had beautiful beaches with swaying palm trees. It had colorful fish swimming in the clear water...but that's not what it was famous for.**

**Some islands are even famous for their  tasty, island food and their  good, island people. Ah...and NOW we're getting very close to what THIS island was famous for. Because, while this island DID have tasty, island food that was yummy in your tummy... it was famous for NOT having that other thing I just told you about. Can you remember what it was?**

*Can you remember?*



**Clue Catchers: Can you find the volcano in the picture?**



**CRUDDY CRETE**

**STAY AWAY!**

**1**

I didn't do it!

**2**

**Liars**

**Cheaters**

pay me MORE!

**3**

Yum, yum, yum!

**4**

**Lazy Over-eaters**

## Story Scene 2

It was good, island people! Yes, THIS island was famous for its BAD, island people.

And that's why, though the name of this island was really just "Crete," most people thought of it more like  "Cruddy Crete." (Cruddy is a word that means something is no good.)

This island was filled with many bad people doing many bad things. There were  liars and  cheaters, and  lazy, over-eaters, just to name a few. And that's why "Cruddy Crete" was really a very good nickname for the island of Crete.

Many people stayed away from Cruddy Crete. After all, why would anyone want to go to a place like this with all these bad people doing all these bad things? Surely there were other islands with beaches and fish and volcanoes and tasty food that had GOOD island people. So why go to one with such BAD people on it?

*Does this sound like an island you would like to visit?*



**Clue Catchers: Can you find the lazy over-eaters in the picture?**



3

Gospel

I didn't do it!

Sinners

THE BIBLE

1

Cruddy Crete

2



## Story Scene 3

Cruddy Crete certainly doesn't sound like any place I would like to visit; but, our story is about two men— Paul and Titus-- who very much wanted to  go there. And as crazy as it sounds, they wanted to go there for the very reason that you and I might NOT want to: all those bad people! There was something very important that Paul and Titus wanted to tell them.

Can you guess what it was that Paul and Titus wanted to tell them?

*What do you think they wanted to tell them?*

Paul and Titus wanted to tell the people of Cruddy Crete  the gospel—the good news that Jesus, the Savior had come and could save them--even them--from their sins.

137

You see, sinners—people who disobey God and His good ways—were exactly the kind of people Jesus had come to save. And Jesus was such a great Savior that there were no people too cruddy and no hearts too full of sin that Jesus could not save them. Jesus could save even the WORST of sinners—even people as bad as those on Cruddy Crete.



**Clue Catchers: Can you find Paul and Titus thinking about the people of Crete?**



## Story Scene 4

Perhaps that's why Paul wanted to go to Crete so very much.

1★ Paul had once been a bad sinner like them. He had been 2★ a hater of Jesus.

3★ 4★ He had done many bad things to hurt Jesus' followers. He had even wanted them dead!

Paul deserved God's punishment for all the bad things he had done; but, God chose to forgive Paul's sins through Jesus, instead.

5★ Paul trusted in Jesus as his Savior and repented of his sins. God saved Paul and changed him.

6★ Paul was so grateful to God for forgiving his sins! And if there was one thing Paul loved to tell others, it was how God could save and change them, too.



Clue Catchers: Can you find Paul and Titus thinking about the people of Crete?

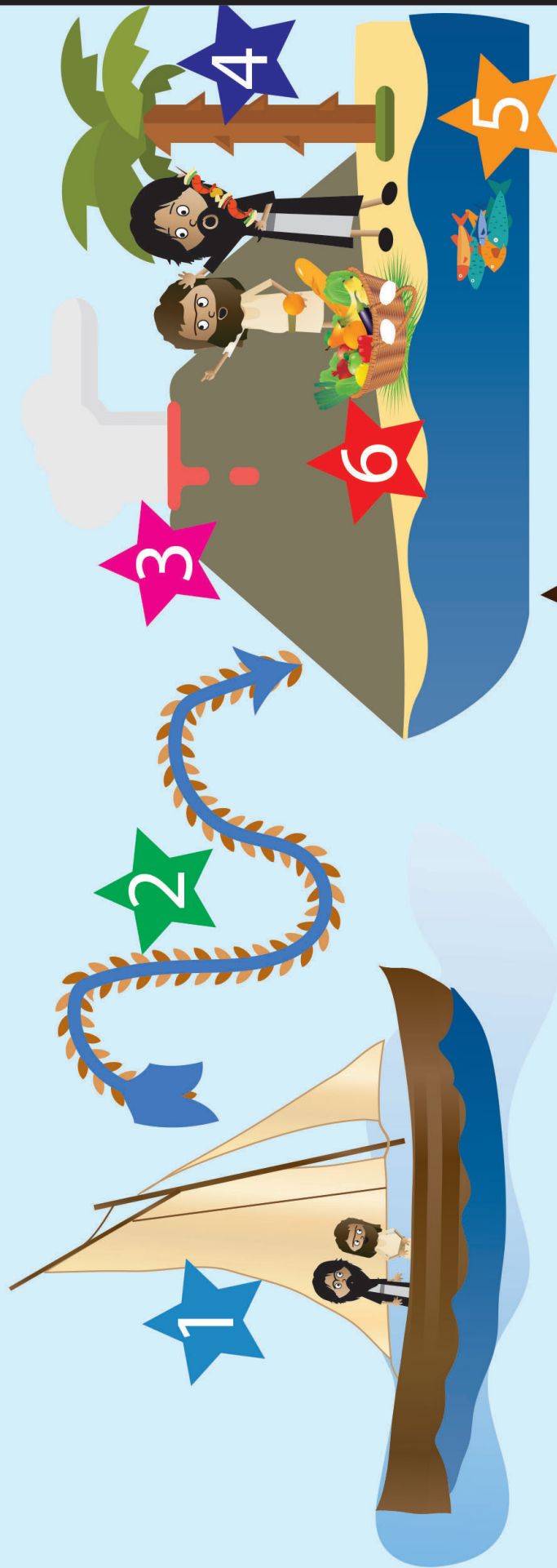

## Story Scene 5

So off Paul went with his young friend, Titus. **1** They headed by boat to Cruddy Crete to tell the people the good news of the gospel.

Paul and Titus sailed over the wavy seas for many days. At last they were so far out to sea that there was nothing to see but water. Where was Crete? Were they lost?

Then, “Land, ho!” Someone spotted an island in the distance. It was Crete—Cruddy Crete--at last!

When Paul and Titus got to Crete, they saw **2** the volcano mountains, **3** the sandy beaches, and **4** the colorful fishes swimming in the clear waters. They saw **5** the swaying palm trees and **6** tasted the good, island food.

Then, **7** they met the island people; and yep, those people were cruddy, all right!

**8** Liars and **9** cheaters and **10** lazy, over-eaters, just to name a few. Oh, how these people needed to know about the Savior, Jesus!

Oh, how these people needed to know about the Savior, Jesus!



Clue Catchers: Can you find Paul meeting the people of Crete?



## Story Scene 6

Paul and Titus went right to work. From town to town they walked,  sharing the good news of Jesus everywhere they went--with the liars and the cheaters and the lazy, over-eaters and everyone else who would listen. And this is the good news of the gospel they shared:

 God is the good King and Creator of the world. He made us and gave us His good laws to live by. But we  have all chosen to disobey God and we deserve His punishment! We need a Savior to save us from our sins.

God, Himself, provided that Savior-- His very, own Son, Jesus.

Jesus came to earth. He lived a perfect life,  then on the cross He suffered and died as the perfect sacrifice for the sins of God's people.  Jesus rose up from the dead on the third day in victory.

 Now all who turn away from their sins and trust in Jesus as their Savior will be saved! They will be God's special people and live with Him forever.  
"Come, repent; come, believe in Jesus! Come, be saved from your sins!" Paul urged the people of Cruddy Crete.

**What would happen? Would they believe? Would they repent?**

*What do you think happened?*



**Clue Catchers: Can you find the picture of the LORD as our Creator and King?**

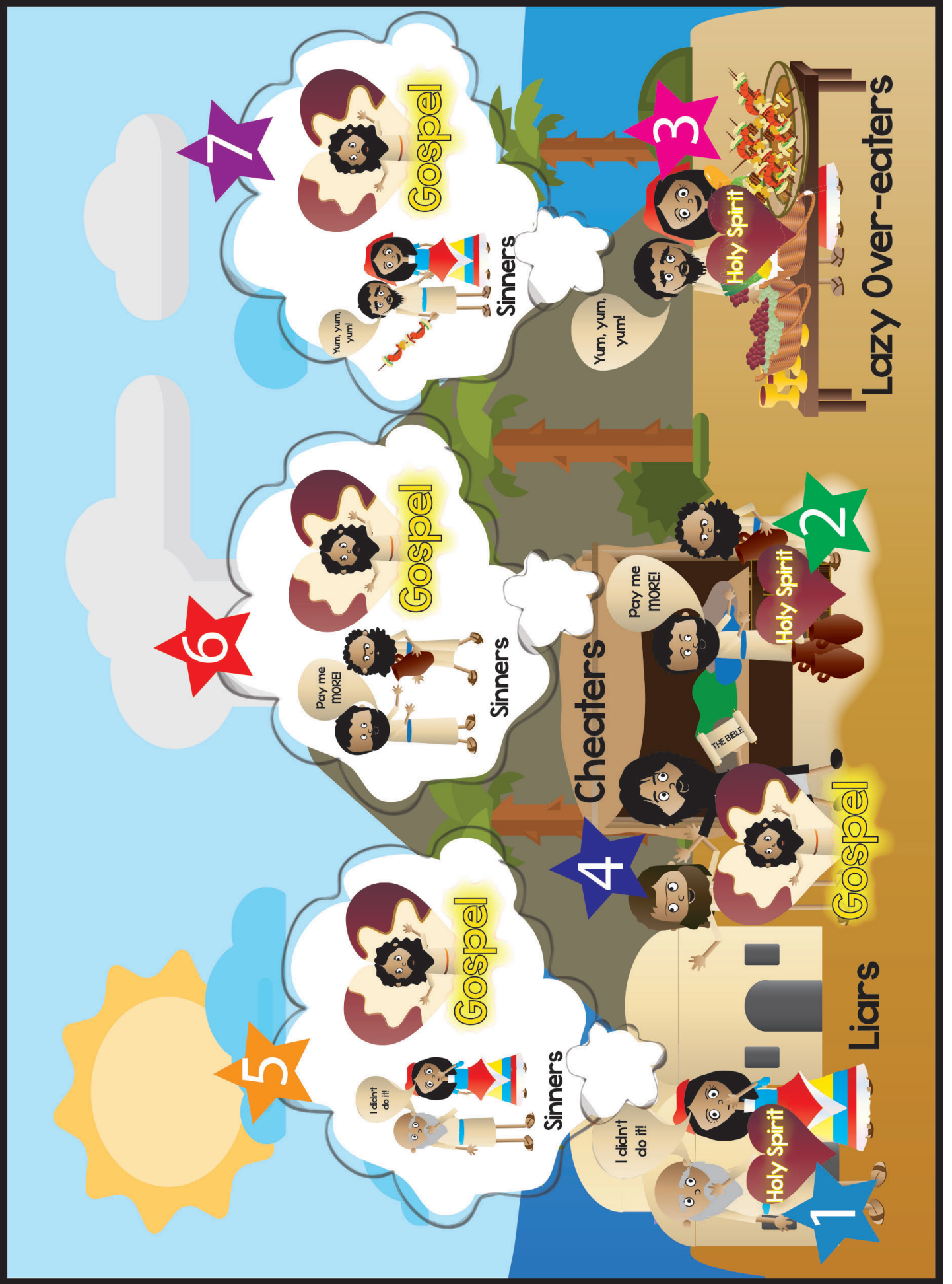

7

Gospel

Sinners

Yum, yum, yum!

3

Holy Spirit

Lazy Over-eaters

Yum, yum, yum!

6

Gospel

Sinners

Pay me MORE!

2

Holy Spirit

Cheaters

pay me MORE!

THE BIBLE

4

Gospel

Gospel

Liars

5

Gospel

Sinners

I didn't do it!

Holy Spirit

1

I didn't do it!



## Story Scene 7

God worked in the **1** hearts of the liars, and the **2** cheaters, and the **3** lazy over-eaters as they listened to **4** Paul preach. **5** **6** They could see that they were sinners. They could see that they needed a Savior. They wanted God's forgiveness through Jesus.

But what **ELSE** had Paul told these people they needed to do to be saved? It wasn't only **BELIEVE**. There was something else they needed to do. Can you remember what it was?

*Can you tell me what it was?*

They needed to **REPENT** and believe. Uh oh! Now **THAT** might be trouble for the people of Cruddy Crete.

That meant it wasn't enough for those cruddy people of Crete to just **BELIEVE** that Jesus was the Savior. That meant it wasn't enough for them just to **TRUST** in Him as their Savior. It might be easy to just believe and trust.

They needed to **REPENT** of their sins, too. They needed to change the way they were living, too. It didn't mean they would be perfect and never sin again. Only Jesus could live a perfect life. But, it **DID** mean that they turned away from lying and cheating and lazy, over-eating as their way of life. They would choose to live for God, instead.

**WOULD** the people of Cruddy Crete do this? **COULD** they do this? They had been such bad people, living their own way for so long!

*What do you think? Could they turn away from their sins?*



**Clue Catchers: Can you find the people of Crete believing in Jesus?**

5

I didn't do it!

Sin Jesus Perfect Life Forgiveness

2

Holy Spirit

Liars

1

Gospel

6

Pay me for that!

Sin Jesus Perfect Life Forgiveness

3

Holy Spirit

Cheaters

7

Yum, yum, yum!

Sin Jesus Perfect Life Forgiveness

4

Holy Spirit

Lazy Over-eaters

## Story Scene 8

**Yes, they COULD; and yes, they WOULD!**

**How? God, Himself, would help them live for Him! He was working in their hearts. He was helping them not only trust in Jesus as their Savior, but also to repent of their sins. 1★ This is the power of the gospel!**

**He would help those 2★ liars turn from their lying, and those 3★ cheaters to turn from their cheating, and those 4★ lazy over-eaters to turn away from their lazy over-eating! Yes! He would help them ALL turn away from living their bad lives...and He would keep on helping them trust in Jesus and live for Him the REST of their lives. God would always be their helper!**

**So right then and there, many people in Cruddy Crete 5★ 6★ 7★ repented of their sins and trusted in Jesus as their Savior. And before long, there were little groups of believers in every town on the island. How happy that made Paul and Titus!**



**Clue Catchers: Can you find the people of Crete turning away from their sins?**

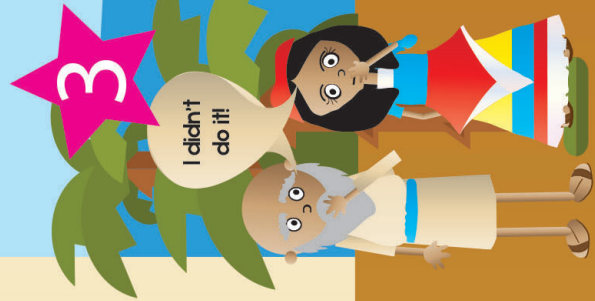
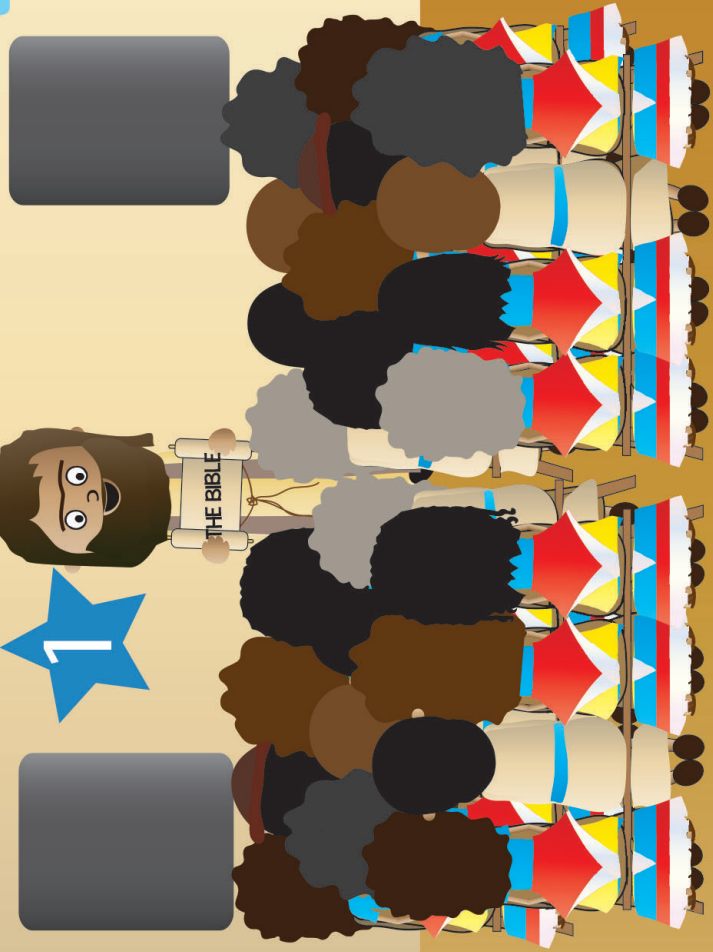
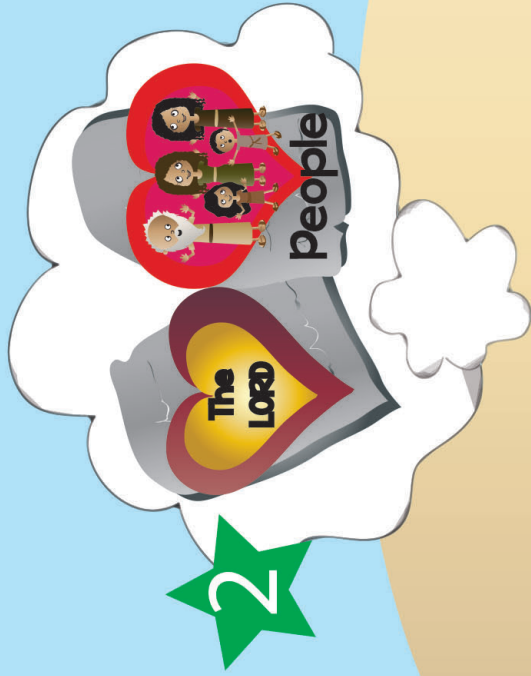

Liars



Lazy Over-eaters

## Story Scene 9

Paul soon set sail for other lands. There were so many more people he wanted to share the good news of Jesus with!

- ★ But Titus stayed right there in Crete, caring for these new believers as their pastor.
- ★ Titus loved them and prayed for them and taught them the Bible.

What a lot of help these people needed! After all, this was Cruddy Crete, where wicked ways were right at home. All around them were people who STILL were ★ liars and cheaters and ★ lazy, over-eaters! And that cruddy, ole sin was so tempting!

It kept wanting to creep right back into their lives and it made it very hard for those new believers to keep on loving God and living for Him.

Oh, how they wanted to love God and live for Him; but oh, how they struggled!



**Clue Catchers: Can you find Titus reading Paul's letter?**

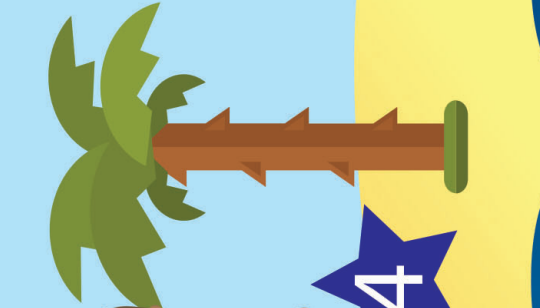
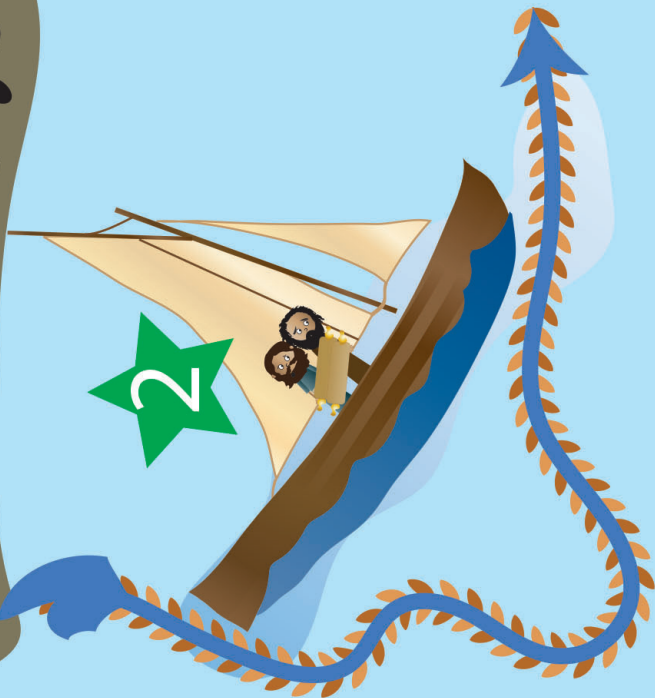
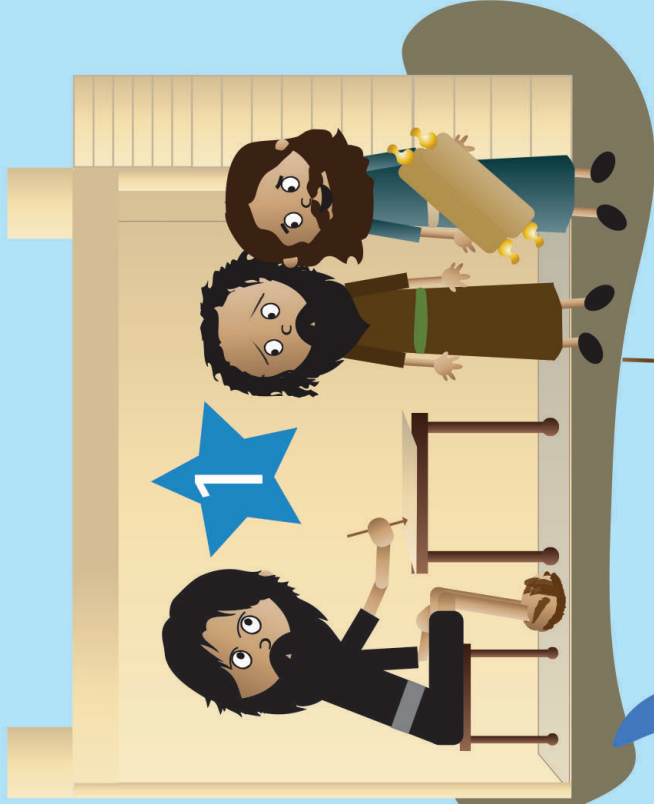
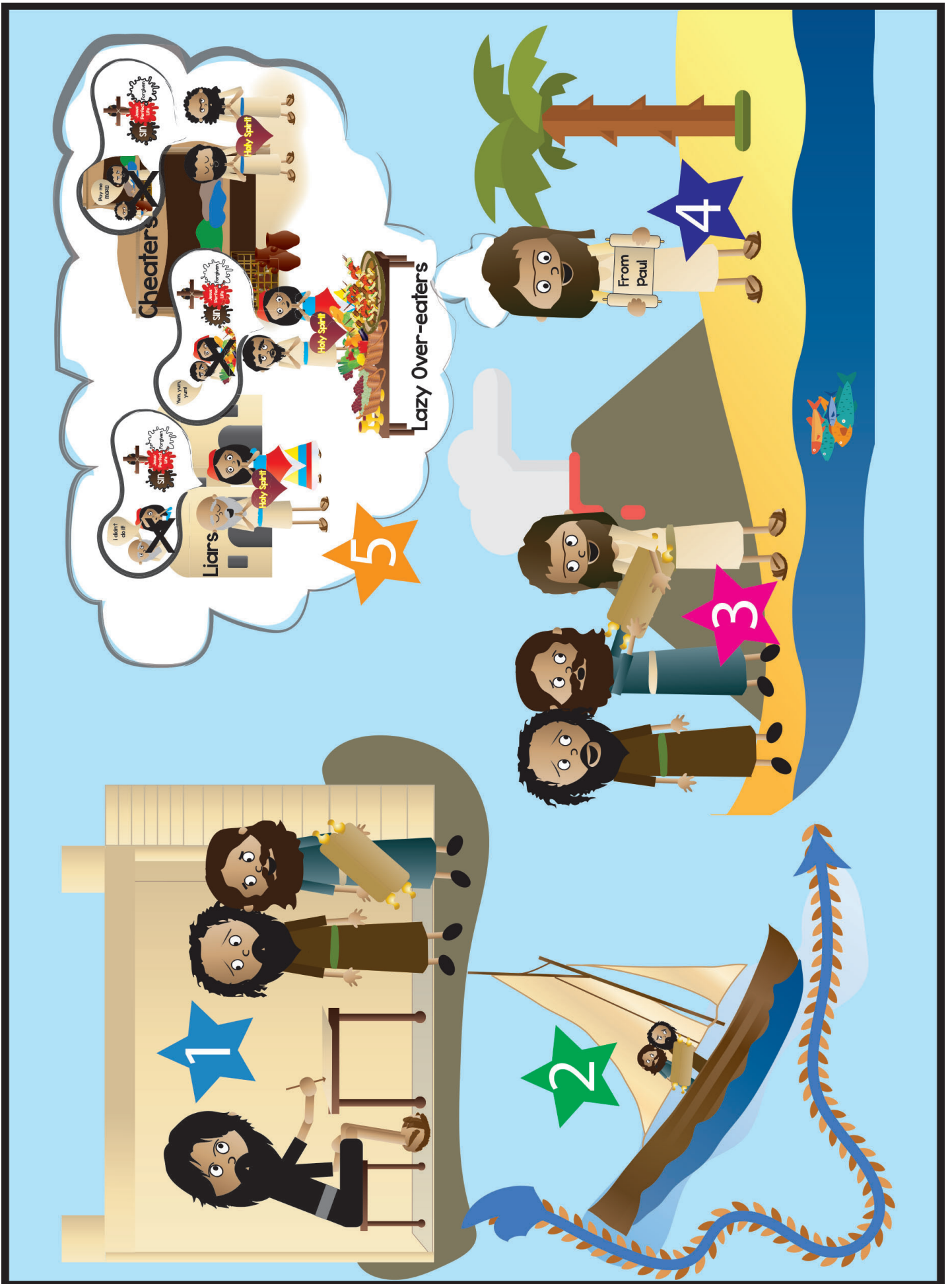

## Story Scene 10

Far away in Corinth, Paul heard about their struggles. He **1** wrote a letter to encourage them. **2** Zenas and Apollos sailed over the wavy seas to Crete and **3** gave it to Titus.

**4** This is what Titus read:

Dear Titus,

I know things are hard in Cruddy Crete. Remind the new believers that the gospel they heard us preach was to repent AND believe. That means God's people need to keep on turning away from their sins AND keep on believing in Jesus every day. This can be very hard, especially on Cruddy Crete—where wicked ways are right at home.

**5** Urge the new believers to keep on turning away from their sins. Urge them to use their lives to do good to each other, to love God, and to hold onto God's Word, the Bible. Remind them that they don't have to do this on their own. The God who helped them repent and believe in Him at the beginning, promises to always be with them. He will help them keep on believing in and living for Him every day.

Say hello to everyone for me. And may God help you live for Him! --Paul

What happened on Cruddy Crete after Titus read Paul's letter and shared it with the believers? Did the new believers keep on repenting of their sins as well as believing in Jesus? The Bible doesn't tell us. It would have been hard to do on Cruddy Crete, but not impossible.

Why? Because God doesn't just help people repent and believe in Jesus at the beginning. He promises to keep helping them to believe in Him and live for Him their whole lives—even in a place like Cruddy Crete, where wicked ways were right at home.



Clue Catchers: Can you find Paul writing to the people of Crete?

**Cracking the Case:** (story wrap-up for Listening Assignments)

It's time to see how we did with our Listening Assignment.

**Detective Dan's Lesson 1 Listening Assignment:**

Cruddy is a word that means something is no good.

**1. What was Crete and what was so cruddy about it?** Crete was an island. It was filled with people who rebelled against God and His good ways. They are what made the island so cruddy.

**2. Who changed in Crete? How did they change?**

Many people changed in Crete when they heard the good news of Jesus. God's Holy Spirit worked in their hearts and helped them to repent of their sins and trust in Jesus as their Savior.

**For You and Me:**

Maybe we don't live in Cruddy Crete, but we need Jesus to be our Savior, just as much as they did. God can help us repent of our sins and trust in Jesus as our Savior, just like He helped them! Ask Him to help you!

**Detective Dan's Lesson 2 Listening Assignment:**

**Our Bible Verse is: Mark 1:15**

"The time has come," he said. "The kingdom of God is near. Repent and believe the good news!"

**1. Who went to Crete to tell the people to repent and believe?** Paul with his young friend, Titus.

**2. What was the gospel that he wanted them to repent and believe in?**

The good news that we can be forgiven our sins and become God's people through Jesus. Paul wanted the people of Crete to repent of their sins and trust in Jesus as their Savior. He wanted them to become God's people, too.

**For You and Me:**

The gospel Paul shared with the people of Crete is for us, too. God offers to forgive our sins and make us His people when we repent of our sins and trust in Jesus as our Savior. Ask Him to help you! He loves to do this!

**Detective Dan's Lesson 3 Listening Assignment:**

Our six clues were: a liar; a palm tree; a pizza; a pair of shoes; a man named Titus; and, a lazy, over-eater.

**1. Which four belong in our story?**

The liar; the palm tree; Titus; and, the lazy, over-eater.

**2. Who repented of their sins and asked God for forgiveness? Who helped them do this?**

Many people in Crete. Paul helped them do this, by telling the gospel and preaching God's Word. God's Holy Spirit helped them do this by working in their hearts as they listened to Paul.

**For You and Me:**

Just like the people in Crete, we have heard the good news of Jesus. Just like them, God calls us to repent of our sins and trust in Jesus as our Savior. God helped the people of Crete repent and believe. He can help us, too. Ask Him to help you!

**The Gospel** (story wrap-up if NOT using Listening Assignments)**Our Bible Truth is:**

**What is the Gospel?**

**It's Salvation through Faith in Jesus Christ...**

**God Saves All Who Repent of Their Sins and Trust in Jesus as Their Savior!**

Like the people in Cruddy Crete, we have all chosen to disobey God and live our own way. We, too, deserve God's punishment for rebelling against Him. What good news is it to hear that God sent Jesus to be our Savior, too. Jesus died on the cross as the perfect payment for sins. On the third day, He rose from the dead, proving He had really beaten sin and death for us!

How can Jesus be our Savior? When we turn away from our sins and trust in Him as our Savior. God delighted to help many people in Crete do this. He can help you, too. Ask Him!

*Close in prayer.*



**Closing ACTS Prayer**

- A** God, we praise You for being so full of love and mercy! You call us to repent and believe in Jesus that we might be saved.
  
- C** We confess that we often disobey You and Your good ways. We choose to live life our own way, not Yours. We need a Savior!
  
- T** Thank God for offering us salvation through Jesus, when we repent of our sins and trust in Jesus as our Savior.
  
- S** God, work in our hearts. Help us to trust in Jesus as our Savior. Help us to joyfully obey You. You know what is best for us and what brings You glory. In Jesus' name we pray. Amen.



Questions to aid discussion of the key concepts and for use in games

Be familiar with these questions and answers. Look for opportunities to ask questions and discuss their answers, such as while the children work on their coloring pages, as part of their response games, or during play time. Remember: your goal isn't to ask all these questions or only talk to the children about these things. It is to be deliberate in having good conversations with them, however much or little you have.

<p><b>BIG QUESTION</b></p> <p><b>Meaning</b></p> <p><b>Discussion Questions</b></p>	<p>What is the Gospel? It's Salvation through Faith in Jesus Christ!</p> <p>Gospel means "good news." In the Bible, the gospel is the good news that God sent His Son Jesus to save sinners like you and me from the punishment we deserve for our sins. That salvation is ours when we turn from our sins and trust in Jesus as our own Savior.</p> <p><i>choose a few</i></p> <ol style="list-style-type: none"> <li>1. What is the gospel? <i>It's salvation through faith in Jesus!</i></li> <li>2. What does the word "gospel" mean? <i>It means "good news."</i></li> <li>3. Why is the gospel such good news? <i>It tells us how can forgive our sins and make us His people forever!</i></li> <li>4. Who do we need to have faith in? <i>Jesus.</i></li> <li>5. What did Jesus do so we can be saved? <i>He took the punishment for sin when He died on the cross.</i></li> <li>6. What does God want us to turn away from? <i>Our sins.</i></li> <li>7. What does it mean to turn away from our sins? <i>To say "no" to disobeying God and to want to obey Him, instead.</i></li> <li>8. Who can we ask to help us turn away from our sins and trust in Jesus? <i>God! He loves to help us when we ask Him.</i></li> </ol>
<p><b>BIBLE TRUTH</b></p> <p><b>Meaning</b></p> <p><b>Discussion Questions</b></p>	<p>It's Salvation through Faith in Jesus Christ...God Saves All Who Repent of Their Sins and Trust in Jesus as Their Savior!</p> <p>God is our good Creator and King. He made us to know Him, love Him and obey His good laws. But sadly, we all have chosen to disobey God and His good laws. We deserve His punishment for our sins. We have all turned away from Him. But God has made a way for us to be forgiven our sins and to become His people. In His great love and mercy, God sent His Son, Jesus to be our Savior. Jesus lived a perfect life. He never disobeyed God. He offered up His life as the full payment for sin when He suffered and died on the cross. On the third day, He rose from the dead. Jesus had done it! He had beaten sin and death for God's people!</p> <p>How can we become one of God's people? Who can receive God's gift of forgiveness? All who repent of their sins and trust in Jesus as their Savior. Repent means to stop living a life full of disobeying God and to start living to please God, instead. God can help us repent and believe. Ask Him! How wonderful it is to be one of God's people! To have special closeness with God by His Holy Spirit living in your heart now. And one day, to go live with God forever. That will be best of all!</p> <p><i>choose a few</i></p> <ol style="list-style-type: none"> <li>1. Who is our good Creator and King? Why do we deserve His punishment? <i>God is our good Creator and King. We deserve His punishment because have all chosen to disobey Him.</i></li> <li>2. What did God do so that we could be forgiven our sins, instead of punished for them? <i>He sent His Son, Jesus to be our Savior. Jesus suffered and died on the cross for our sins in our place.</i></li> <li>3. How can Jesus be our Savior? What do we need to do? <i>We need to repent of our sins and trust in Him as our Savior.</i></li> <li>4. What does it mean to repent of our sins? <i>To stop living a life of disobeying God and to start living to please God, instead.</i></li> <li>5. Who can help us repent and believe? <i>God can! Ask Him!</i></li> </ol>

*Questions to aid discussion of the key concepts and for use in games*

<p><b>THE GOSPEL</b></p>	<p>What is God’s good news for you and me? <i>The gospel!</i></p> <p><i>God made all people--including you and me! And He made us to know Him, love Him and obey Him. He’s our good king, but we have all chosen to disobey Him. We all deserve His punishment. How sad! But God is so merciful! He sent a Savior, His Son, Jesus. Jesus suffered and died on the cross. He offered up His perfect life to God to completely pay for the sins of God’s people. That includes us, when we turn away from our sins and trust in Jesus as our Savior. He loves to help us do this. Ask Him! How good is God to us!</i></p>
<p><b>BIBLE TRUTH BIBLE VERSE</b></p> <p><b>Meaning</b></p> <p><b>Discussion Questions</b></p>	<p>“The time has come,” he said. “The kingdom of God is near. Repent and believe the good news!” --Mark 1:15</p> <p><b>Learn a Little:</b> “Repent and believe the good news!”</p> <p>For years and years, God had promised to send a Savior to save us from our sins. For years and years, people waited and watched...and they watched and waited. At last, Jesus came! He taught the people about God and did amazing things. He showed them that He was God’s Son, the Savior God had promised. But what did people have to do, if they were to be forgiven by God for their sins? Jesus told them: “Repent and believe in the gospel--the good news that Jesus was God’s Son, the Savior, sent to save them. We can be forgiven, too, when we repent--that is, turn away from disobeying God and living life our own way-- and believe that Jesus is God’s Son, the Savior. God loves to help us do this. Ask Him!</p> <p><i>choose a few</i></p> <ol style="list-style-type: none"> <li>1. What is God’s kingdom? <i>God’s people, living with God, as He wants them to live.</i></li> <li>2. What is the gospel? <i>It’s the good news about the Savior, Jesus.</i></li> <li>3. Who did God promise to send at just the right time? <i>The Savior, Jesus.</i></li> <li>3. What did Jesus do when He came? <i>He told people about God and did amazing things. He showed them that He was the Savior. He suffered and died for our sins. He rose to life in victory.</i></li> <li>4. What did Jesus tell people to do, if they wanted to become God’s people? <i>Repent of their sins and believe that He is the Savior.</i></li> <li>5. How does “repent” mean? <i>To turn away from disobeying God and live to please Him, instead.</i></li> <li>6. Who can help us repent and believe? <i>We can ask God to help us to turn away from our sins and trust in Jesus as our Savior. He loves to answer these prayers!</i></li> </ol>
<p><b>BIBLE STORY</b></p> <p><b>Discussion Questions</b></p>	<p><b>The Case of the Changes in Cruddy Crete</b></p> <p><i>choose a few</i></p> <ol style="list-style-type: none"> <li>1. What made Crete so cruddy? <i>The people were sinners who chose to live their own way instead of God’s good way. They were especially known for being liars, cheats, and lazy over-eaters.</i></li> <li>2. What did Paul and Titus come to tell them? <i>The good news of Jesus that they might be saved.</i></li> <li>3. What two things did Paul tell them they needed to do, if they were to be saved? <i>Repent of their sins and believe in Jesus as their Savior.</i></li> <li>4. How does “repent” mean? <i>To turn away from disobeying God and live to please Him, instead.</i></li> <li>5. Why would it be hard for the people of Crete to repent of their sins? <i>They would have to stop living the way they had been living and start living a completely different way.</i></li> <li>6. Who helped the people of Crete repent and believe? <i>God did. His Holy Spirit worked in their hearts as they listened to Paul preach.</i></li> <li>7. Who stay to help the new believers in Crete? <i>Titus did.</i></li> <li>8. How did Paul encourage the new believers when he heard they were struggling? <i>He wrote them a letter and urged them to keep on believing in God and keep on repenting. He told them God would help them.</i></li> </ol>

**CAN YOU GUESS BIBLE TRUTH 4:**  
**What's the Gospel?**  
**It's Salvation through Faith**  
**in Jesus Christ...**

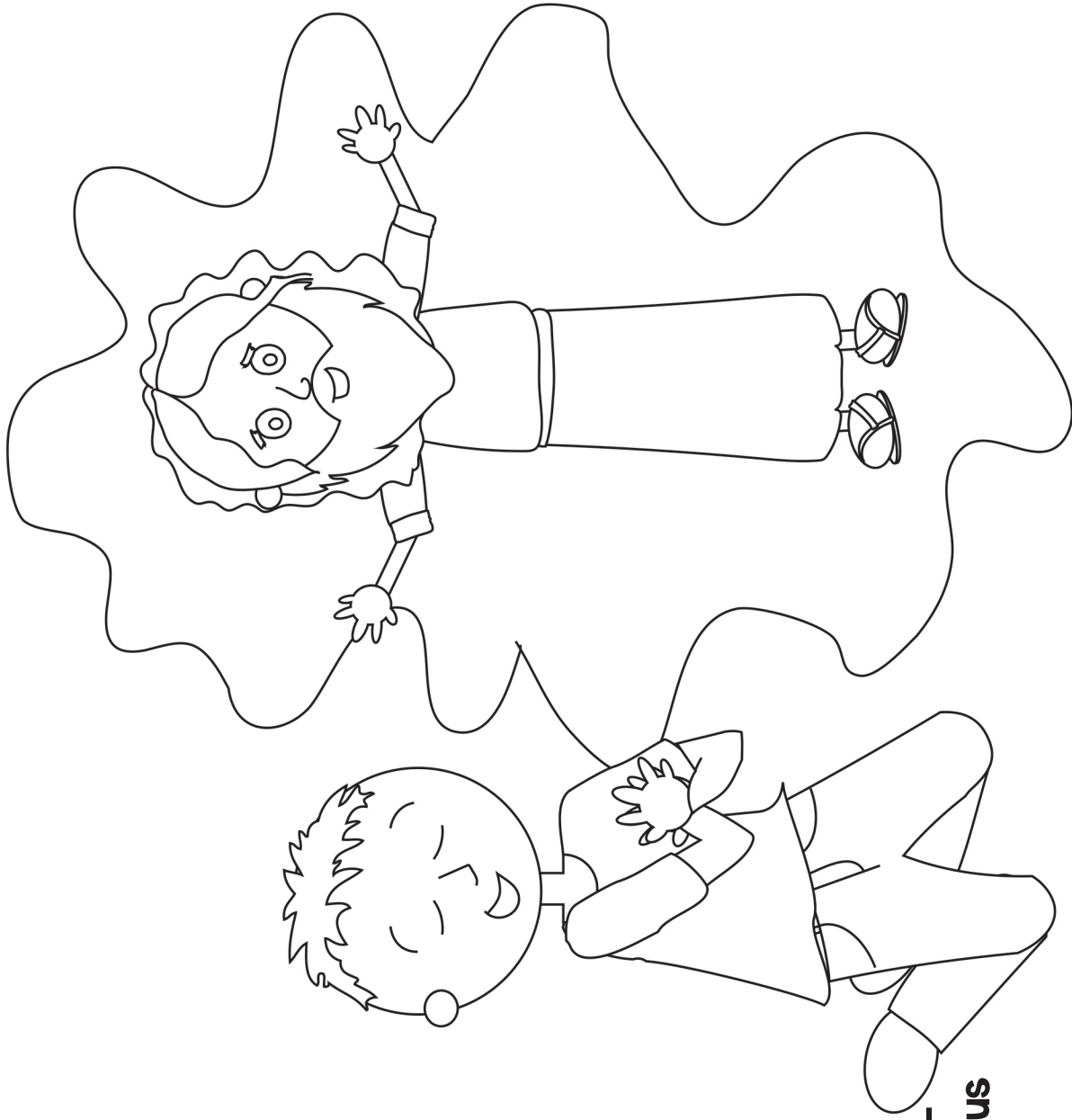

**God saves all who**  
**-----**  
**of their sins and trust in Jesus**  
**as their Savior!**

**HINT: What's the Bible word for turning away from**  
**disobeying God? It rhymes with "cement."**

# Deep Down Detective Devotion: Unit 3, Bible Truth 4, Lesson 1



## Big Question 3 : What Is the Gospel?

**Answer:** It's Salvation through Faith in Jesus Christ...

God Saves All Who Repent of Their Sins and Trust in Jesus as Their Savior!

## Bible Truth 4 Meaning

God is our good Creator and King. He made us to know Him, love Him and obey His good laws. But sadly, we all have chosen to disobey God and His good laws. We deserve His punishment for our sins. We have all turned away from Him. But God has made a way for us to be forgiven our sins and to become His people. In His great love and mercy, God sent His Son, Jesus to be our Savior. Jesus lived a perfect life. He never disobeyed God. He offered up His life as the full payment for sin when He suffered and died on the cross. On the third day, He rose from the dead. Jesus had done it! He had beaten sin and death for God's people!

How can we become one of God's people? Who can receive God's gift of forgiveness? All who repent of their sins and trust in Jesus as their Savior. Repent means to stop living a life full of disobeying God and to start living to please God, instead. God can help us repent and believe. Ask Him! How wonderful it is to be one of God's people! To have special closeness with God by His Holy Spirit living in your heart now. And one day, to go live with God forever. That will be best of all!

## How do I know this is true? The Bible tells me so!

"The time has come," he said. "The kingdom of God is near. Repent and believe the good news!" --- Mark 1:15

## Some Questions for You

1. Who is our good Creator and King? *Why do we deserve His punishment? God is our good Creator and King. We deserve His punishment because we have all chosen to disobey Him.*
2. What did God do so that we could be forgiven our sins, instead of punished for them? *He sent His Son, Jesus to be our Savior. Jesus suffered and died on the cross for our sins in our place.*
3. How can Jesus be our Savior? What do we need to do? *We need to repent of our sins and trust in Him as our Savior.*
4. What does it mean to repent of our sins? *To stop living a life of disobeying God and to start living to please God, instead.*
5. Who can help us repent and believe? *God can! Ask Him!*

## Let's Pray!

- A** God, we praise You for being so full of love and mercy! You call us to repent and believe in Jesus that we might be saved.
- C** We confess that we often disobey You and Your good ways. We choose to live life our own way, not Yours. We need a Savior!
- T** Thank God for offering us salvation through Jesus, when we repent of our sins and trust in Jesus as our Savior.
- S** God, work in our hearts. Help us to trust in Jesus as our Savior. Help us to joyfully obey You. You know what is best for us and what brings You glory. In Jesus' name we pray. Amen.

## Let's Sing about What We're Learning!

### Big Q & A 3 Song from Deep Down Detectives NIV Songs 3, track 12

(sung to the tune of "Oh, My Darlin' Clementine")

What's the gospel?  
What's the gospel?  
Can you tell me what it is?  
It's salvation through faith in Jesus,  
That's what the gospel is. (repeat)

### Big Question 3 Action Rhyme Song from Deep Down Detectives NIV Songs 3, track 13

#### Refrain:

What is the gospel? G-O-S-P-E-L?	"G" is for God, our good King and Creator, O, we should obey Him, but instead we're disobeyers, So S, we need a Savior to save us from our sins, That Savior is Jesus, who "P" took the punishment.	Yes, Jesus died upon the cross, the perfect sacrifice, Then on Day Three, He rose again To prove He'd won the fight,  And now "E" everyone who repents and believes in Him, He gives "E-L" eternal life: forever life with Him. <i>Refrain</i>
What is the gospel? Can anybody tell me? What is the gospel? Yes, I know what it is! Salvation through faith in Christ, That's what the gospel is.		

**“The time has come,” he said. “The kingdom of God is near.  
Repent and believe the good news!” --- Mark 1:15**



## Deep Down Detective Devotion: Unit 3, Bible Truth 4, Lesson 2



**Big Question 3 :** What Is the Gospel?

**Answer:** It's Salvation through Faith in Jesus Christ...

God Saves All Who Repent of Their Sins and Trust in Jesus as Their Savior!

**How do I know this is true? The Bible tells me so!**

"The time has come," he said. "The kingdom of God is near. Repent and believe the good news!" --- Mark 1:15

**Learn a Little:** "Repent and believe the good news!"

**Meaning**

For years and years, God had promised to send a Savior to save us from our sins. For years and years, people waited and watched...and they watched and waited. At last, Jesus came! He taught the people about God and did amazing things. He showed them that He was God's Son, the Savior God had promised.

But what did people have to do, if they were to be forgiven by God for their sins? Jesus told them: "Repent and believe in the gospel--the good news that Jesus was God's Son, the Savior, sent to save them. We can be forgiven, too, when we repent--that is, turn away from disobeying God and living life our own way-- and believe that Jesus is God's Son, the Savior. God loves to help us do this. Ask Him!

**Some Questions for You**

1. What is God's kingdom? *God's people, living with God, as He wants them to live.*
2. What is the gospel? *It's the good news about the Savior, Jesus.*
3. Who did God promise to send at just the right time? *The Savior, Jesus.*
4. What did Jesus do when He came? *He told people about God and did amazing things. He showed them that He was the Savior. He suffered and died for our sins. He rose to life in victory.*
5. What did Jesus tell people to do, if they wanted to become God's people? *Repent of their sins and believe that He is the Savior.*
6. How does "repent" mean? *To turn away from disobeying God and live to please Him, instead.*
7. Who can help us repent and believe? *We can ask God to help us to turn away from our sins and trust in Jesus as our Savior. He loves to answer these prayers!*

**Let's Pray!**

- A** God, we praise You for being so full of love and mercy! You call us to repent and believe in Jesus that we might be saved.
- C** We confess that we often disobey You and Your good ways. We choose to live life our own way, not Yours. We need a Savior!
- T** Thank God for offering us salvation through Jesus, when we repent of our sins and trust in Jesus as our Savior.
- S** God, work in our hearts. Help us to trust in Jesus as our Savior. Help us to joyfully obey You. You know what is best for us and what brings You glory. In Jesus' name we pray. Amen.

**Let's Sing Our Bible Verse!**

**The Time Has Come** *from Deep Down Detectives NIV Songs 3, track 22*

"The time has come," he said,  
"The kingdom of God is near.  
Repent and believe the good news."

"The time has come," he said,  
"The kingdom of God is near.  
Repent and believe the good news."  
Mark One, fifteen.

*Go to the Deep Down Detectives Parent Resources for Unit 3 to get the Bible story and many more resources and songs for this unit at [praisefactory.org](http://praisefactory.org)*



Which four of these clues belong in our story? Which two do not? Put an X in the boxes of the four that belong.

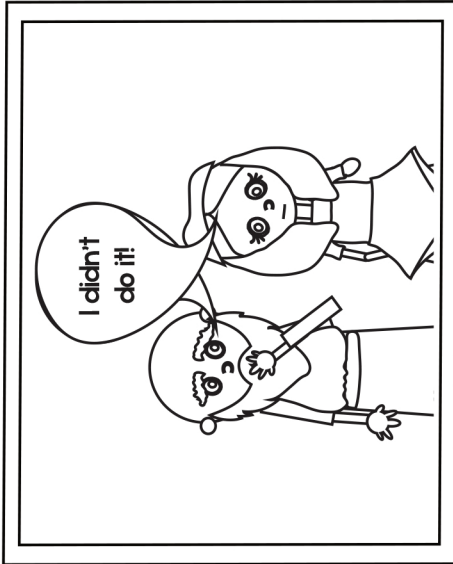

A Liar

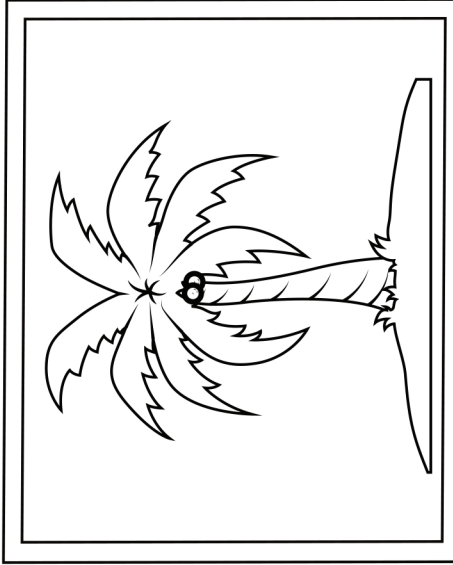

A Palm Tree

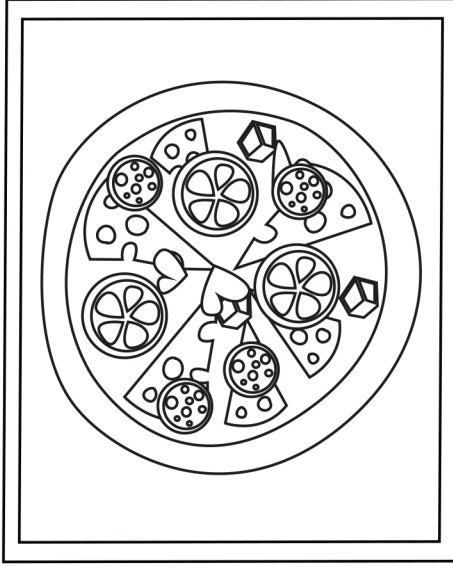

A Pizza

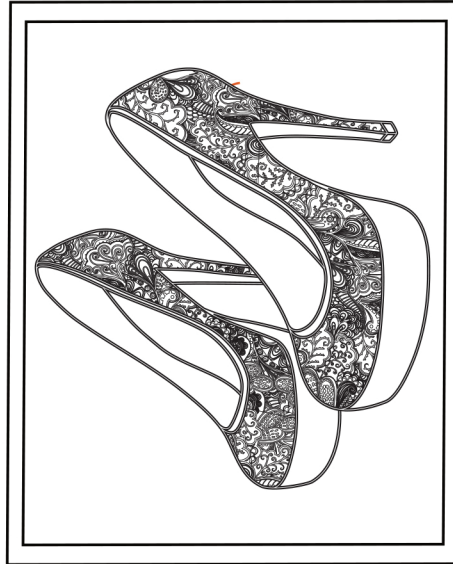

A Pair of Shoes

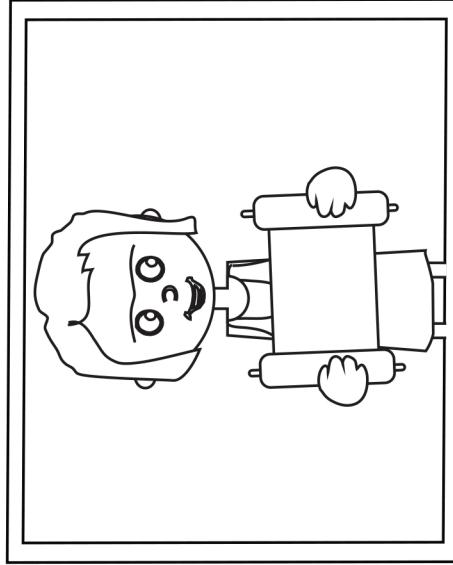

A Man Named Titus

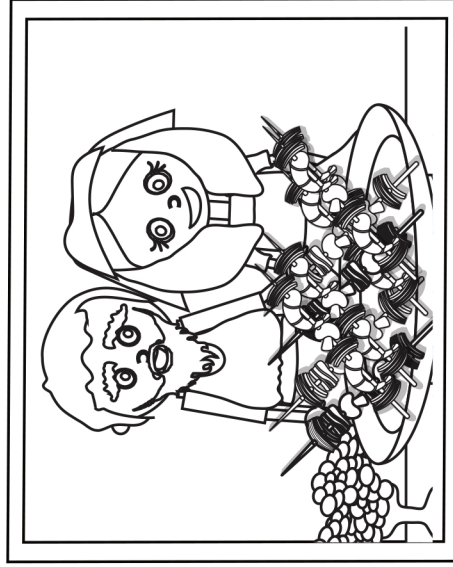

A Lazy, Over-eater

Answer: The liar; the palm tree; Titus; and, the lazy, over-eater belong in the story. The pizza and shoes do not.

# Deep Down Detective Devotion: Unit 3, Bible Truth 4, Lesson 3



**Big Question 3** : What Is the Gospel?

**Answer:** It's Salvation through Faith in Jesus Christ...

God Saves All Who Repent of Their Sins and Trust in Jesus as Their Savior!

## Bible Truth 4 Meaning

God is our good Creator and King. He made us to know Him, love Him and obey His good laws. But sadly, we all have chosen to disobey God and His good laws. We deserve His punishment for our sins. We have all turned away from Him. But God has made a way for us to be forgiven our sins and to become His people. In His great love and mercy, God sent His Son, Jesus to be our Savior. Jesus lived a perfect life. He never disobeyed God. He offered up His life as the full payment for sin when He suffered and died on the cross. On the third day, He rose from the dead. Jesus had done it! He had beaten sin and death for God's people!

How can we become one of God's people? Who can receive God's gift of forgiveness? All who repent of their sins and trust in Jesus as their Savior. Repent means to stop living a life full of disobeying God and to start living to please God, instead. God can help us repent and believe. Ask Him! How wonderful it is to be one of God's people! To have special closeness with God by His Holy Spirit living in your heart now. And one day, to go live with God forever. That will be best of all!

## How do I know this is true? The Bible tells me so!

"The time has come," he said. "The kingdom of God is near. Repent and believe the good news!" --- Mark 1:15

## Some Questions for You

Our six case clues were: a liar; a palm tree; a pizza; a pair of shoes; a man named Titus; and, a lazy, over-eater.

1. Which four belong in our story? *The liar; the palm tree; Titus; and, the lazy, over-eater.*
2. What made Crete so cruddy? *The people were sinners who chose to live their own way instead of God's good way. They were especially known for being liars, cheats, and lazy over-eaters.*
3. What did Paul and Titus come to tell them? *The good news of Jesus that they might be saved.*
4. What two things did Paul tell them they needed to do, if they were to be saved? *Repent of their sins and believe in Jesus as their Savior.*
5. How does "repent" mean? *To turn away from disobeying God and live to please Him, instead.*
6. Why would it be hard for the people of Crete to repent of their sins? *They would have to stop living the way they had been living and start living a completely different way.*
7. Who helped the people of Crete repent and believe? *God did. His Holy Spirit worked in their hearts as they listened to Paul preach.*
8. Who stay to help the new believers in Crete? *Titus did.*
9. How did Paul encourage the new believers when he heard they were struggling? He wrote them a letter and urged them to keep on believing in God and keep on repenting. He told them God would help them.

## Let's Pray!

- A** God, we praise You for being so full of love and mercy! You call us to repent and believe in Jesus that we might be saved.
- C** We confess that we often disobey You and Your good ways. We choose to live life our own way, not Yours. We need a Savior!
- T** Thank God for offering us salvation through Jesus, when we repent of our sins and trust in Jesus as our Savior.
- S** God, work in our hearts. Help us to trust in Jesus as our Savior. Help us to joyfully obey You. You know what is best for us and what brings You glory. In Jesus' name we pray. Amen.

## Let's Praise God Right Now!

### Big Q & A 3 Hymn: And Can It Be

from *Deep Down Detectives NIV Songs 3, track 17*

#### Refrain

Amazing love, how can it be?  
That thou, my God, should die for me?  
Amazing love, how can it be?  
That thou, my God, should die for me?

Words: Charles Wesley Music: Thomas Campbell

### Big Question 3 Praise Song: I Have Decided to Follow Jesus

from *Deep Down Detectives NIV Songs 3, track 18*

I have decided to follow Jesus,  
I have decided to follow Jesus,  
I have decided to follow Jesus,  
No turning back, no turning back.

Go to the *Deep Down Detectives Parent Resources for Unit 3* to get the Bible story and many more resources and songs for this unit at [praisefactory.org](http://praisefactory.org)

DDD BQ 10 BT4 L3 Coloring Sheet/Take Home pg2  
DDD BQ 3 BT 4 L3 Coloring Sheet/Take Home pg2

# Cheaters Are Changed

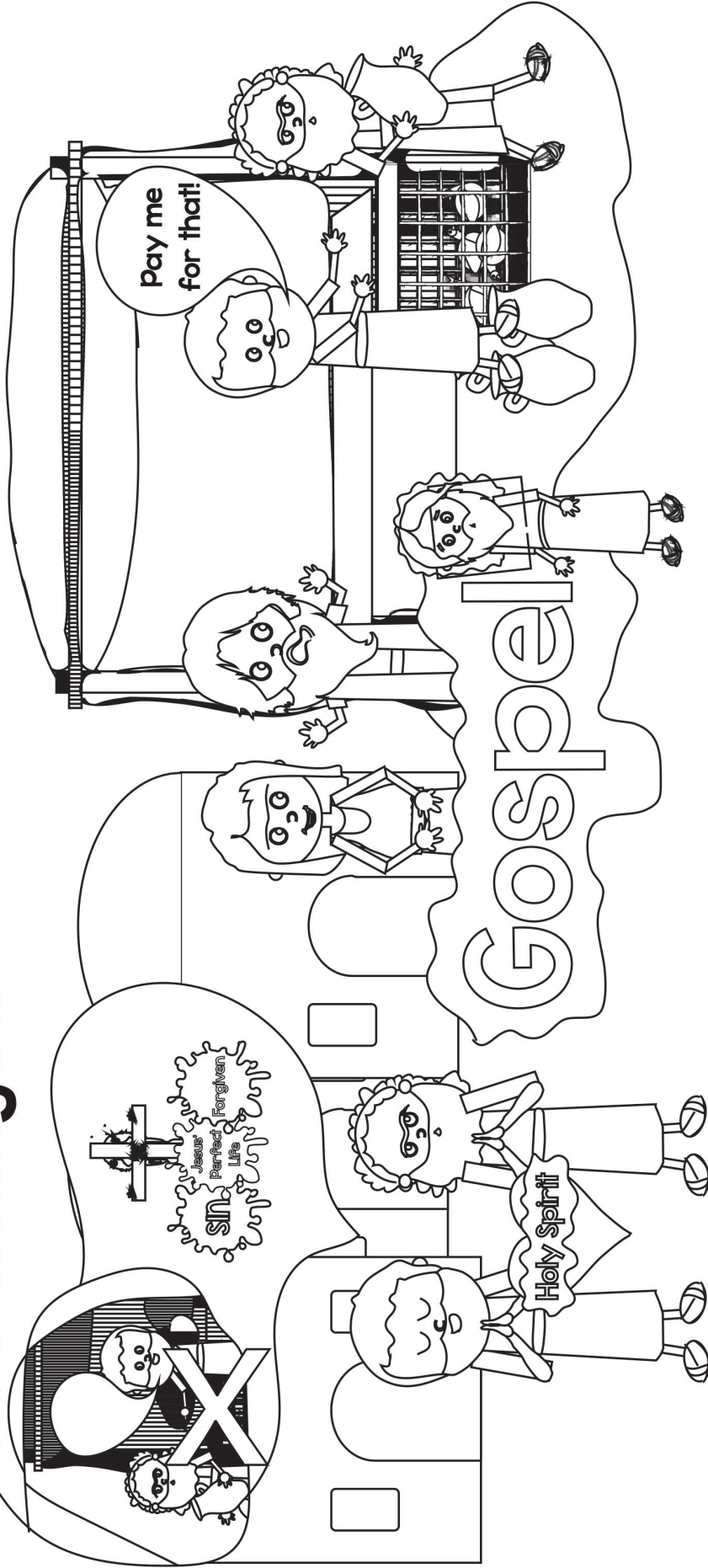

Our Big Question is: "What is the Gospel?" We've learned that "it's Salvation through Faith in Jesus Christ... God saves all who repent of their sins and trust in Jesus as their Savior!" How do we know this? The Bible tells us so. We've been learning a Bible story about how God saved even the people in "Cruddy Crete." They were known for the ways they disobeyed God, but when they trusted in Jesus as their Savior, they turned away from living that kind of life. Now they lived for God instead. That's what it means to repent. God helped those people in Crete repent and trust in Jesus as their Savior. He can help us do that, too. Ask Him!

## The Case of the Changes in Cruddy Crete Jigsaw Puzzle Page Titus

Make copies of picture and cut out into an appropriate number of pieces for your children. Or, you can print out color versions of this puzzle by downloading it from [praisefactory.org](http://praisefactory.org).

Our Big Question is: "What Is the Gospel?" We've learned that "It's Salvation through Faith in Jesus Christ...God saves all who repent of their sins and trust in Jesus as their Savior!" How do we know this? The Bible tells us so. We've been learning a Bible story about how God saved even the people in "Cruddy Crete." They were known for the ways they disobeyed God, but when they trusted in Jesus as their Savior, they turned away from living that kind of life. Now they lived for God instead. That's what it means to repent. God helped those people in Crete repent and trust in Jesus as their Savior. He can help us do that, too. Ask Him!

